

Saramonic

2.4GHz Four-Channel
Wireless Microphone System

2.4GHz四通道无线麦克风系统

Blink500 ProX B8

User Manual
用户手册

Statement

Please read this manual carefully before using and strictly operate and store it in accordance with the instructions. Please save the manual for your future reference. If you need further assistance than the user manual, please consult your retailer for help or email us: info@saramonic.com

Cautions

1. DO NOT remove the housing yourself.
2. Please keep it away from heat sources such as radiators or spotlights.
3. DO NOT remove the battery without a professional's help.
4. When cleaning, use only a soft, dry cloth to clean the unit.
5. When using and storing, please keep it away from dust and moisture places.
6. For the best pick-up pattern, do not hold your hand against the microphone capsule cover.

Features

Blink500 ProX TXR-WP Transmitter

- Up to 280 meters of wireless transmission (without obstacles)
- High-performance noise cancellation algorithms - 48kHz/ 24bit HD audio format retained
- Wide-range 20-20,000Hz frequency response - deliver exceptional high-quality sound
- 8GB of memory - store up to 14 hours of recording
- Transmitter' USB-C port - connect to a laptop or smartphone to read recording files
- Up to 11 hours of operating time (about 6.5 hours when the onboard recording is enabled)
- Comes with a windproof microphone capsule - minimize unwanted wind noise
- Features the water-resistance and dust-resistant housing rated IP65

Blink500 ProX 4RX Receiver

- Separate 4-track audio output
- Receiver's 3.5mm headphone output - monitor your audio in real-time
- High-resolution OLED display - see vital information at a glance
- Selectable Mono/ Stereo output setting
- Dual 3.5mm TRS analog output - free to connect with cameras, smartphones and computers, etc

Introduction

The Saramonic Blink500 ProX B8, a four-channel wireless microphone system, has four sound sources miked up simultaneously with ease. The audio of four tracks is able to be separately output by the receiver at the same time, which is enough for audio post-production.

The transmitter features high-performance noise cancellation, which is available for improving the recording effect in a noisy environment. It also boasts a remarkable onboard recording which is available for storing your recording files in real-time.

It is possible to use the kit in many ways. You can choose to use the transmitter with the 3.5mm external lavalier microphone, your line input devices, or its built-in microphone as your needs. Dual 3.5mm TRS output ports allow the receiver to connect with two devices such as cameras, mixers, smartphones, tablets, laptops, and more. The kit comes with a charging case for carrying on with ease.

This kit can record multiple sound sources. It is suitable for 4-person performances, conferences, speeches, podcasts, vlogging, mobile journalism, and more. In addition, coming with a windproof capsule and water-resistant housing, the transmitter provides a great solution for shooting in rainy weather or recording while taking exercise outdoors.

* The Blink500 ProX B8 operates on the 2.4GHz spectrum and automatically hops to free channels to avoid static noise and audio dropouts.

* The Blink500 ProX 4RX receiver can work with Blink500 ProX TX, Blink500 ProX TXQ, Blink500 ProX TXL, Blink500 ProX TXR, or Blink500 ProX TXR-WP transmitter.

Product Structure

Wireless Transmitter Blink500 ProX TXR-WP

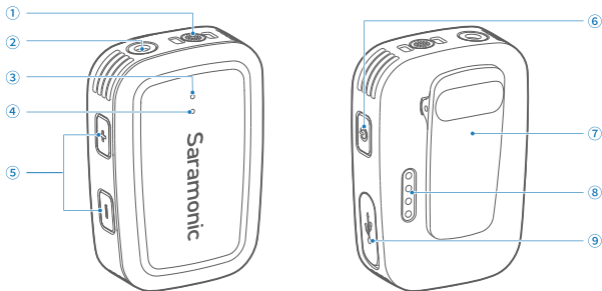

① Built-in Microphone

The capsule is fabricated with a wind-resistant diaphragm, which can minimize unwanted wind noise and handling noise, etc.

② Mic/ Line Input Jack

It can be connected to the 3.5mm lavalier microphones, and other 3.5mm microphones or line-in devices.

③ Recording Indicator

Blinking Pattern	Status
Blinking red	Mute
Static red	Onboard recording ON

HINT: • When mute and onboard recording are enabled at the same time, the indicator will show mute status.

- Enabling mute won't affect the onboard recording.

④ Status Indicator

Blinking Pattern	Status
Blinking blue slowly	Unpaired
Blinking blue quickly	Pairing

Static blue	Paired successfully or Fully charged
Blinking red	Low battery
Static red	Charging
Lights up yellow	Line input mode
Blinking blue 3 times quickly	Maximum gain
Static green	Noise cancellation enabled

⑤ +/- Button

- Press "+" or "-" button to adjust the mic gain from 0 to 6 level.
- Press and hold the "+" and "-" button at the same time for 2 seconds to switch between mic input or line input. When switching to line input, the status indicator lights up yellow.
- Press and hold the "-" button for 2 seconds to enable or disable the onboard recording.

HINT:

- The max recording time is approximately 14 hours at the 48kHz/ 24bit sampling rate.
- The file will be automatically split after 30 minutes of recording, making it easy to quickly find your desired recording segment.
- By default, the recording files are named with consecutive numbers, such as REC-001.WAV. Up to 999 recording files can be created.
- If the memory is full, the original file will be automatically overwritten with the latest file from the beginning.

⑥ Power Button

Function	Operation
Power ON/ OFF	Press and hold for 2 seconds
Mute ON/ OFF	Press
Enter the pairing status	Press and hold for 5 seconds in shutdown status
Noise cancellation enabled/ disabled	Press twice

⑦ Belt Clip

⑧ Charging Contacts

⑨ USB-C Port

Used for charging. Can also be used to read recording files and check remaining memory after connecting to a smartphone or computer.

Wireless Receiver Blink500 ProX 4RX

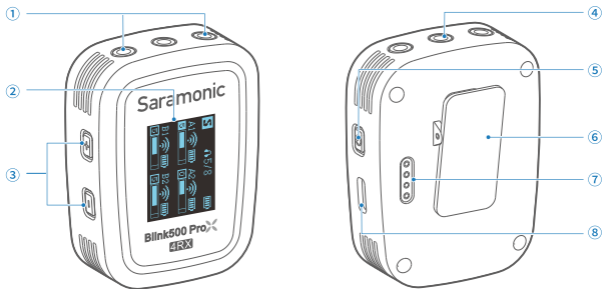

① LINE OUT Jack

There are 2 LINE OUT jacks for connecting the Blink500 ProX 4RX to a smartphone, tablet, camera, recorder, or mixer with the supplied output cables.

② OLED Display

For more details, please refer to "Receiver's Screen Overview".

③ +/- Button

- On home screen, press the "+" / "-" button to turn up or down your headphone volume or the mic gain; press and hold "+" to enter the menu screen.
- On menu screen, press the "+" / "-" button to select different functions or values shown on the display; press and hold "+" to access options or confirm your setting; press and hold "-" to return to home screen.

④ 3.5mm Headphones Output

Connect headphones for audio monitoring.

⑤ Power/Mute Button

- Press and hold the button for 2 seconds to power the receiver on or off
- After the transmitter and receiver are paired, press the button to select the mic gain or the headphone volume to adjust.

⑥ Belt Clip

⑦ Charging Contacts

⑧ USB-C Charging Port (DC 5V)

Charging Case Blink500 ProX BOXMAX

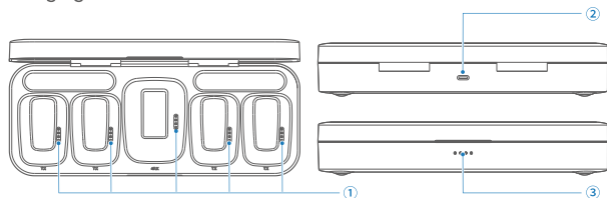

① Charging Contacts

Place the transmitter(s) and receiver in the charging case until it magnetically snaps into place.

② USB-C Charging Port (DC 5V)

③ Charging Indicators

Indicator	Status
	Low battery
	Charging
	Full charged
	Transmitter/ Receiver is being charged

Receiver's Screen Overview

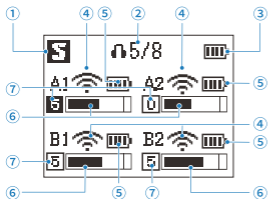

Home screen

If no operation is performed within 20 seconds on menu screens, the display will automatically return to home screen.

- 4RX's output mode**
 Mono Stereo
- Headphone volume**
 On home screen, press +/- button to adjust the headphone volume.
- 4RX battery level indicator**
 Displays the current battery level. Please recharge the device immediately when the indicator starts flashing.
- RF level indicator**
 Indicates the current signal level.
 - Signal is strong (Paired successfully)
 - Signal is weak (Paired successfully)
 - No signal (Disconnected)
- Transmitter's battery level indicator**
 Displays the current battery level of the transmitter. Please recharge the device immediately when the indicator starts flashing.

- Audio input level meter**
 Displays the audio input level.
- Transmitter's mic gain**
 On the Home screen, press the 4RX's power button to select the gain of the transmitter A1, A2, B1, or B2, and then press the 4RX's "+" / "-" button to adjust the mic gain.

Menu screen

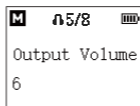

Headphone Output Volume

The headphone monitoring volume can be set from 0 to 8. Default is "5".

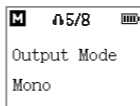

Output Mode Setting

The output mode can be set to either Mono or Stereo. When in Mono mode, the audio from the transmitter, or transmitters will be mixed to both the left and right sides. When in Stereo mode, the two transmitters' audio output will be separated to the left and right sides. Default is "Mono".

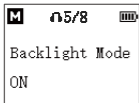

Backlight Setting

Set backlight to always on or on for 10s/ 30s/ 60s. Default is "ON".

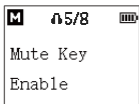

Mute Key Setting

Enable or disable mute key button function. Default is "Enable".

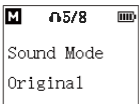

Sound Mode Setting

The sound can be set to either Original mode or Vocal Boost mode. When in the Original mode, the high-fidelity audio will be picked up. When in the Vocal Boost mode, the vocal will be emphasized and the low frequencies will be reduced.

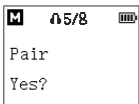

Pair Setting

Pair with the transmitter. For details of operation, please refer to "Operation Guide".

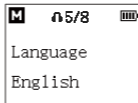

Language Setting

English or 简体中文 (Chinese) are available. Default is "English".

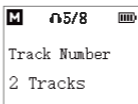

Track Number Setting

The track number can be set 2 or 4. Default is "4".

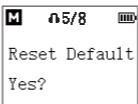

Restore Default Setting

How to Use

1. Press and hold the power buttons for 2 seconds to turn on the receiver and the transmitter(s).

2. Pairing.

Before leaving factory, the system is pre-paired. Therefore, the connection will be established once they are powered on. If they are disconnected, please follow below steps:

- ① Turn off all the transmitters, and long press the 4RX's SET button to enter menu screen.
- ② Use the + or - button to display the "Pair Setting" menu.

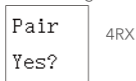

- ③ Long press the SET button to select the menu.



- ④ Select "Yes", and long press the SET button to confirm. The receiver enters the pairing mode, and the RF level indicator will flash.
- ⑤ Press and hold transmitter(s)' power button for 5 seconds in shutdown mode to enter the pairing mode. The indicator will flash blue rapidly. To avoid channel crowding, please turn on the next transmitter to pair after the previous transmitter is successfully paired.
- ⑥ Transmitter and receiver will be successfully paired within 10 seconds. Audio input level meter on

the receiver's home screen will show the volume of the transmitter.

3. Connect the receiver to the mic input of a camera, recorder or mixer with the supplied dual 3.5mm TRS to TRS Y-cable. Or connect the 4RX to a smartphone, tablet, or computer with the supplied dual 3.5mm TRS to TRRS Y-cable.

4. You are ready to record.

Tips:

- ① Please turn on the receiver first and then turn on the transmitter to pair.
- ② If you need to add other transmitters during use, turn off all the transmitters currently connected, and then re-pair with the receiver in turn.
- ③ SR-2019 and SR-2020 adapter cables (sold separately) are available for needs of four-track audio output.

Pairing Order

1. If there was a need to use four transmitters at the same time, they would be divided into Channel Group A and Channel Group B in groups of two transmitters.
2. After the receiver enters the pairing mode, it will pair with the transmitters in the order of Channel Group A1, A2, B1, and B2.
3. As the pairing is finished, the pairing order and the channel groups will remain unchanged as long as the transmitters are not turned off during use.

Auto Reconnection Order

If the dual 3.5mm TRS to TRS(TRRS) Y-cable is connected to the receiver which is in mono output mode, the audio from four transmitters will be mixed to output.

Note: After restoring the receiver's default settings, the user can randomly shuffle the original pairing order of transmitters belonging to channel group A/ B. That is, the transmitter originally belonging channel group B can also be connected to the A channel.

M/S Output Mode

1. When a transmitter reconnects to the receiver, its channel is the same as the previously paired channel.
2. In stereo mode, whether the audio output is two-track or four-track, the audio from group A1 / B1 transmitters is delivered to the left side, and the audio from group A2 / B2 transmitters is delivered to the right side.

Note: The audio of group A1 / A2 transmitters is delivered from the receiver's OUT1 port, and the audio of group B1 / B2 transmitters is delivered from the receiver's OUT2 port.

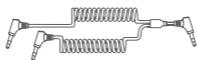

3.5mm TRS→TRS

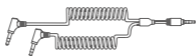

3.5mm TRS→TRRS

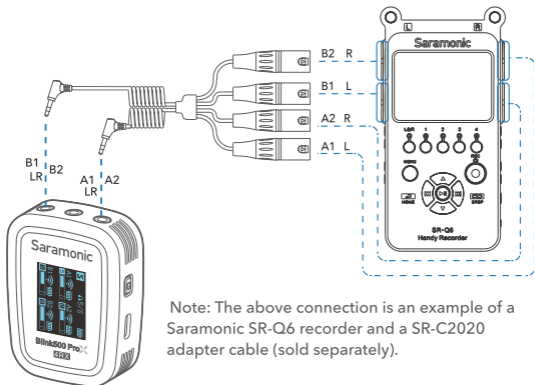

Note: The above connection is an example of a Saramonic SR-Q6 recorder and a SR-C2020 adapter cable (sold separately).

Troubleshooting

If you encounter problems when using the unit, please refer to the following checklist before contacting technical support. If the problem cannot be solved, please contact the dealer's after-sales service department.

- **If there is no sound from the unit or no sound when connected to an external device**
 - ① Make sure the receiver is well connected to your device properly.
 - ② Make sure the gain and volume are not turned to a minimum.
 - ③ Make sure the transmitter(s) is not muted.
 - ④ Make sure the transmitter's input mode is proper.
 - ⑤ If there is no sound from an output, make sure the receiver is in stereo output mode first, and then verify that there is sound from the other output.

- **If sound of the unit is too low or too loud or even distorted**
 - ① Adjust the mic gain and output volume and find the most suitable level for recording in the current situation to improve the recording effect.
 - ② If you are recording in noisy environment, it is recommended to enable noise cancellation to improve the recording effect.

- **Current noise or other abnormal noise appears during monitoring**

Make sure there is no interference near the unit. If the noise still exists after changing the unit's position, please contact our customer service.

- **The operating range of the unit is limited and the sound is frequently intermittent**

Make sure there is no interference between the transmitter(s) and receiver. If the intermittent sound still occurs frequently, please contact our customer service.

- **The receiver failed to output audio from multiple tracks**
 - ① Make sure the receiver is connected to the proper audio cable. Please refer to the above "How to Use" for details.
 - ② Make sure the connected audio cable is proper for the receiver's track numbers. If the four-track output is needed, the track numbers should be set to "4 Tracks", and the output mode should be set to "Stereo" in the receiver's menu. And connect the receiver to your device with a dual TRS to four TRS (XLR) splitter.
 - ③ If the connection still fails, please contact our customer service.

- **If Noise Cancellation isn't working as expected on your transmitter.**

Check that the transmitter is set to line input mode. The noise cancellation will be disabled automatically when the transmitter is in line input mode.

- **Failed to load files when the transmitter is connected to the computer**
Check that the transmitter has onboard recording enabled. The recording files are failed to read when the onboard recording is on.
- **Failed to charge the transmitter(s) or receiver via the charging case**
 - ① Make sure the charging contacts of both are in full contact. Wipe the charging contacts with a clean cloth and try again.
 - ② If you want to check whether the magnetic force is aging or whether the charging contacts of the two are not in sufficient contact, press the transmitter(s) placed in the charging box to check that it is in a charging state. If the transmitter(s) or receiver still failed to be charged, please contact our customer service.
 - ③ Check that the battery level of the charging case is low.
- **The units failed to automatically power on when the charging case opens.**
Please close the case first and then reopen it after 10 seconds. If the units still failed to power on, please contact our customer service.

In the Box

- Blink500 ProX TXR-WP Transmitter × 4
- Blink500 ProX 4RX Receiver × 1
- Blink500 ProX BOXMAX Charging Case × 1
- Fur Windshield for Built-in Microphone × 4
- Lavalier Microphone × 4
- USB-A to USB-C Charging Cable × 1
- Dual 3.5mm TRS to 3.5mm TRS Y-Cable for Camera × 1
- Dual 3.5mm TRS to 3.5mm TRRS Y-Cable for Smartphone × 1
- Dual 3.5mm TRS Male to Four 3.5mm TRS Male Cable (SR-C2019) × 1
- Carrying Pouch × 1

Other Adapter Cables (sold separately)

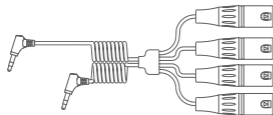

Dual 3.5mm TRS Male to Four XLR Male Cable (SR-C2020)

Specifications

Blink500 ProX TXR-WP Transmitter

Transmission Type	2.4GHz Digital Frequency
Modulation	Digital Modulation
Polar Pattern	Omnidirectional
Antenna	Built-in Antenna
Operating Range	Up to 280m (Measured in open environment without obstacles and interference.)
RF Output Power	<10mW
Frequency Response	20Hz-20kHz
Sensitivity	-37dB
Signal-to-Noise Ratio	> 80dB
Distortion	≤0.1%
Delay	9.7ms
Audio Input	Built-in Microphone or 3.5mm Mic/ Line Input Jack
Power Requirements	Built-in Li-ion Battery or Charging Contacts or USB-C Port (DC 5V)
Battery Capacity	400mAh
Battery Life	Approx. 6.5 hours (Onboard recording enabled)
	Approx. 11 hours (Onboard recording disabled)
Charging Time	Approx. 2 hours
Memory	8GB
Recording Time	Approx. 14 hours
Recorded Audio Format	48KHz/ 24bit, WAV
IP Rating	IP67
Weight	30.5g
Dimensions	56mm×38mm×15.5mm
Operating Temperature	0°C to 50°C
Storage Temperature	-10°C to 50°C

Blink500 ProX 4RX Receiver

Display	OLED
Transmission Type	2.4GHz Digital Frequency
Modulation	Digital Modulation
Antenna	Built-in Antenna
Operating Range	Up to 280m (Measured in open environment without obstacles and interference.)
RF Output Power	<10mW
Frequency Response	20Hz-20kHz
Signal-to-Noise Ratio	> 80dB
Distortion	≤0.1%
Delay	9.7ms
Audio Output Level	-5dBu~-66dBu@-40dBu in
Audio Output Channel	4 Channels or 2 Channels
Audio Output Mode	Mono or Stereo
Audio Output Connector	3.5mm TRS LINE OUT Jack
Monitor Connector	3.5mm TRS Headphones Jack
Power Requirements	Built-in Li-ion Battery or Charging Contacts or USB-C Port (DC 5V)
Battery Capacity	800mAh
Battery Life	Approx. 11 hours
Charging Time	Approx. 2 hours
Weight	56g
Dimensions	66mm×49mm×21mm
Operating Temperature	0°C to 50°C
Storage Temperature	-10°C to 50°C

Blink500 ProX BOXMAX Charging Case

Power Requirements	Powered by USB-C Port (DC 5V)
Battery Capacity	4500mAh
Case's Charging Time	Approx. 3 hours
Charge Cycle Times for Microphones	1 Times
Weight	343.5g
Dimensions	224mm×90mm×38mm
Operating Temperature	0°C to 50°C
Storage Temperature	-10°C to 50°C

声明

请在使用前仔细阅读本手册，并严格按照说明进行操作和存储。请妥善保存好说明书以供将来参考。如果用户手册不能帮助您解决某些问题，请向零售商寻求帮助或给我们发送电子邮件：info@saramonic.com。

注意事项

1. 请勿擅自拆开机壳；
2. 请勿将本机靠近热源，如散热器、聚光灯或其他产生热量的设备；
3. 电池不可自行更换；
4. 请使用柔软的干布清洁本设备；
5. 在使用和储存时，请注意防尘和防潮；
6. 为获得最佳拾音效果，请勿将手放在麦克风咪头上。

特点

Blink500 ProX TXR-WP发射器

- 无线传输距离达280米（无障碍）
- 自研高性能降噪算法，且支持48kHz/24bit高清音频格式
- 20-20,000Hz频响范围，高品质还原真实声音
- 内置8GB储存芯片，最高支持板载录音时长约为14小时
- 发射器Type-C口支持连接电脑/手机等读取录音文件
- 11小时单次超长续航（板载录音功能开启后约为6.5小时）
- 内置防风膜片，支持裸机三级运动防风
- IP65级外壳防尘防水设计

Blink500 ProX 4RX接收器

- 支持4轨音频独立输出
- 接收器支持接入3.5mm耳机实时监听
- 高分辨率OLED屏幕，重要信息一目了然
- 自由切换单声道/立体声输出模式
- 3.5mm TRS双模拟输出孔——自由连接相机、手机、电脑等设备

概述

枫笛Blink500 ProX B8套件是一款四通道无线麦克风系统,支持对四个声音源同时进行录制。接收器支持四通道同步独立输出,提供了强大的后期音频处理空间。发射器不仅具有高性能降噪功能,从容应对嘈杂的录音环境,还支持板载录音,可以对录音文件实时存档。

使用方式多样,除内置麦克风外,发射器也可外接3.5mm领夹麦/线性输入设备使用。接收器具有3.5mm TRS双线性输出孔,自由连接相机、混音器、智能手机、平板或电脑等设备。配套充电盒让其便于出行携带。

该套件能够满足需要多个声音源的活动需求,适用于多人表演、会议、演讲、播客、Vlog拍摄、街头采访等场景。此外,发射器支持裸机防水防风,让您无忧雨天拍摄、运动拍摄、户外收音等情况。

* Blink500 ProX B8所使用的是抗干扰2.4GHz频段,遇到干扰情况下能自动跳转频道避免噪音产生以及音频失真。

* Blink500 ProX 4RX接收器可搭配同系列Blink500 ProX TX、Blink500 ProX TXQ、Blink500 ProX TXL、Blink500 ProX TXR、和Blink500 ProX TXR-WP发射器使用。

产品结构

Blink500 ProX TXR-WP无线发射器

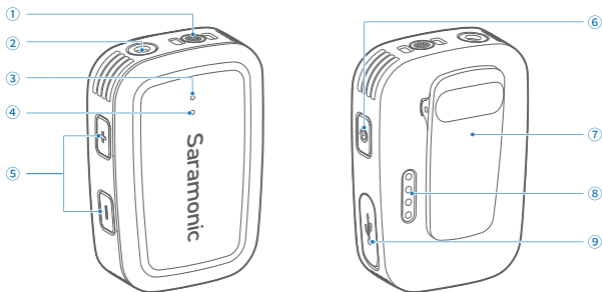

① 内置麦克风

内含防风膜片,有效减少风噪声、触摸杂音等。

② 麦克风/线性输入

连接3.5mm领夹麦或其他3.5mm麦克风/线性输入设备。

③ 录音指示灯

闪灯方式	产品状态
红灯闪烁	静音状态
红灯常亮	板载录音开启

注: • 静音和板载录音同时开启时,将优先展示静音状态。

• 开启静音模式并不会影响板载录音功能。

④ 状态指示灯

闪灯方式	产品状态
蓝灯慢闪	未联机
蓝灯快闪	对码中
蓝灯常亮	联机成功/充满电
红灯闪烁	低电量

红灯常亮	充电中
黄灯亮起	线性输入模式
蓝灯快闪3次	最大增益
绿灯常亮	降噪开启

⑤ +/-键

- 短按+/-按键增加或减少麦克风增益(共7档)。
- 同时长按+键和-键2秒即可切换麦克风输入/线性输入,当切换到线性输入时,状态指示灯亮起黄灯。
- 长按-键2秒可开启/关闭板载录音功能。

注:

- 在48kHz/24bit采样率下,内存支持最大存储14小时录音时长;
- 录音满30分钟后将自动分割文件,便于快速查找想要的录音片段。
- 录音文件默认命名格式为“REC-001.WAV”,最高支持999个录音文件。

⑥ 电源键

功能	操作
开/关机	长按按键2秒
静音开启/关闭	短按按键
进入对码状态	关机状态下长按按键5秒
降噪开启/关闭	双击按键

⑦ 背夹

⑧ 充电触点

⑨ Type-C接口

用于充电;也可用于连接至手机/电脑读取录音文件,查看剩余内存。

Blink500 ProX 4RX无线接收器

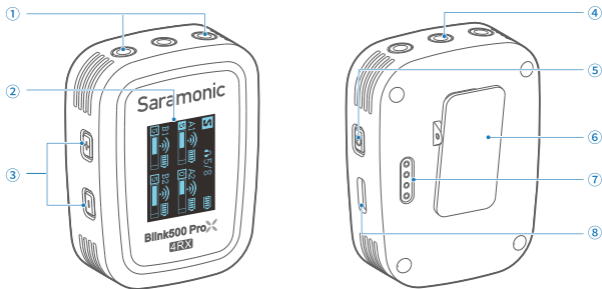

① LINE OUT 线性输出孔

2 个 LINE OUT 插孔, 用于使用随附输出线将 Blink500 ProX 4RX 连接至手机、平板电脑、相机、录音笔或混音器等设备。

② OLED 显示屏

详情参考“接收器屏幕介绍”。

③ +/-键

- 在主界面上, 短按 +/- 键可增减耳机监听音量和麦克风增益, 长按 +/- 键则进入菜单界面。
- 在菜单界面上, 短按 +/- 键可调整各参数值或功能, 长按 +/- 键则进入选项或保存设定, 长按 - 键返回到主界面。

④ 3.5mm 耳机插孔

接入耳机进行音频监听。

⑤ 电源键



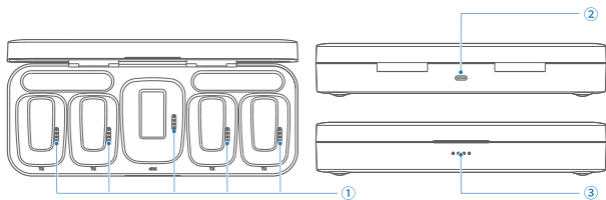

- 长按按键 2 秒开/关机。
- 在与发射器成功配对的状态下, 短按按键可选定发射器增益或接收器音量进行下一步调节。

- ⑥ 背夹
- ⑦ 充电触点
- ⑧ Type-C 充电口 (直流电 5V)

Blink500 ProX BOXMAX充电盒



- ① 充电触点
将发射器/接收器放入充电盒中，直至其触点固定到位。
- ② Type-C 充电口 (直流电5V)
- ③ 电量指示灯

指示灯	状态
	低电量
	充电中
	充满电
	盒内产品充电中

接收器屏幕介绍

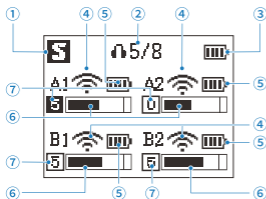

主菜单界面

如果超过 20 秒不操作，显示屏会自动跳转回主菜单界面。

① 接收器输出模式

M 单声道 **S** 立体声

② 耳机监听音量

在主界面上，短按 +/- 键可调节耳机输出音量大小。

③ 接收器电量指示

显示接收器电量情况，若图标为空格且开始闪烁，请及时进行充电。

④ RF 信号强度指示

用来指示当前信号强度。

信号强（配对成功）

信号弱（配对成功）

无信号显示（未联机）

⑤ 发射器电量指示

显示发射器电量情况，若图标为空格且开始闪烁，请及时进行充电。

⑥ 实时输入电平指示

显示实时输入电平大小。

⑦ 发射器麦克风增益

在主界面上，短按 4RX 电源键选定发射器 (A1、A2、B1、B2) 的增益后，再短按 +/- 键可以调节麦克风增益大小。

菜单介绍

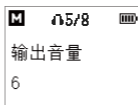

输出音量设置

输出音量调节范围 (0~8)，默认设置为“5”。

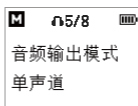

音频输出模式设置

输出模式可以设置为单声道或立体声。在单声道模式下，音频将混合到左右两边通道。在立体声模式下，两个发射器的音频将分离到左右两通道输出。默认设置为“单声道”。

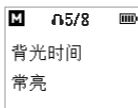

背光时间设置

背光灯时间可设置为常亮、10 秒、30 秒、或 60 秒，默认设置为“常亮”。

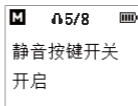

静音按键功能设置

开启或关闭静音按键功能，默认设置为“开启”。

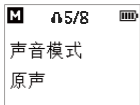

声音模式设置

声音模式可以设置为原声和人声增强。在原声模式下，本机将采取高保真拾音；在人声增强模式下，本机将减少低频并突出人声。

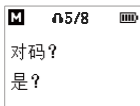

对码设置

与发射器配对，具体操作请参考“操作指南”。

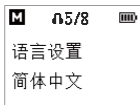

语言设置

English/ 简体中文可供选择，默认设置为“English”。

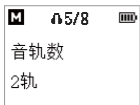

音轨数设置

音轨数可设置为 2 或 4，默认设置为“4”。

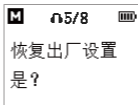

确认恢复出厂设置后，Blink500 ProX 4RX 的相关参数将被恢复到默认出厂值。

操作指南

1. 长按电源键2秒，将发射器和接收器开机。

2. 配对。

发射器和接收器出厂前已配对成功。因此，产品开机之后会自动联机。若未成功连接，请进行如下配对操作：

- ① 将发射器全部关机，长按接收器SET 按键进入菜单界面。
- ② 使用 + 或 - 按钮在接收器上显示“对码设置”菜单。

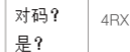

③ 长按 SET 键选择菜单。



④ 选择“是”，长按 SET 键确认，接收器进入对码状态，RF 信号强度指示呈闪烁状态。

⑤ 在发射器关机状态下，长按其电源键5秒以进入配对状态，指示灯呈蓝灯快闪。为避免通道抢占，请在前一个发射器对码成功后再对下一个发射器进行开机对码操作。

⑥ 发射器和接收器将在 10 秒内完成配对。配对成功后,接收器主页的实时输入电平指示会显示发射器的音量状态。

3. 使用随附的双头 3.5mm TRS 转 TRS 音频转接线将接收器连接至相机、录音笔或混音器等设备。或者使用随附的双头 3.5mm TRS 转 TRRS 音频转接线将接收器连接至手机、平板电脑等移动设备。

4. 开始录制。

注:

- ① 请先启动接收器后启动发射器进行配对操作。
- ② 若使用过程中需要增加其他发射器,则将目前所连全部发射器关机后,重新与接收器依次配对即可。
- ③ 若有四轨音频输出的需求,可以使用 SR-2019 或 SR-2020 音频转接线(单独出售)。

对码顺序

1. 如果有需求同时使用 4 个发射器,那么其中 2 个发射器属于通道组 A,另外 2 个发射器属于通道组 B。
2. 接收器进入对码状态后,会以 A1、A2、B1、B2 通道组的顺序依次与发射器完成对码。
3. 对码完成后的使用期间,只要发射器不关机,则一直为配对时的连接顺序,且通道不变。

回连顺序

发射器回连接接收器的通道与之前配对的通道保持一致。

注:在恢复出厂设置后,用户可以随机打乱原属于 A/B 通道组的发射器的配对顺序。即原先属于 B 通道组的发射器,在恢复默认设置后可以连接到 A 通道。

M/S 声道输出模式

1. 在单声道音频输出模式下,接收器连接双头 3.5mm TRS 转单头 TRS/TRRS 音频线时,A1/A2/B1/B2 组发射器的音频将被混合输出。
2. 在立体声音频输出模式下,无论是二轨音频输出还是四轨音频输出,A1/B1 组发射器的音频将输出到左声道,A2/B2 组发射器的音频将输出到右声道。

注:接收器 OUT1 孔输出 A1/A2 组发射器的音频,OUT2 孔输出 B1/B2 组发射器的音频。



3.5mm TRS→TRS



3.5mm TRS→TRRS

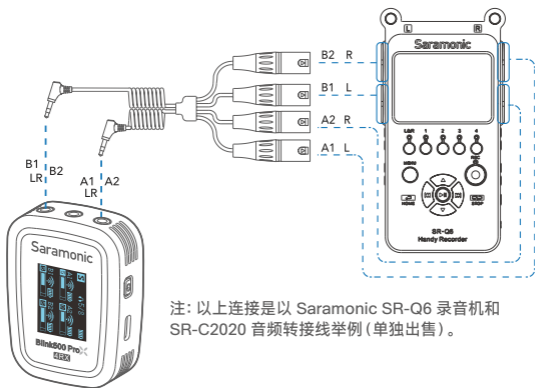

注：以上连接是以 Saramonic SR-Q6 录音机和 SR-C2020 音频转接线举例（单独出售）。

故障排除

在使用本机的过程中出现任何问题，请参照以下内容加以解决。如果此手册仍然无法解决您遇到的问题，请与我们当地的经销商售后服务部联系。

- 本机无声音

- ① 检查产品是否连接正常以及转接线是否有松动。
- ② 检查增益、音量是否被调至最低。
- ③ 检查发射器、接收器是否开启了静音模式。
- ④ 检查发射器是否输入模式不对应。
- ⑤ 若某个输出孔无声音，检查接收器是否切换成了立体声模式，并验证另一个输出孔是否有声音。

- 本机声音过小或过大甚至破音

- ① 通过调节增益/音量，找到最适合当前环境录制的档位，提高录制效果。
- ② 若录音环境较为嘈杂，可开启发射器的降噪模式，提高录制效果。

- 监听时有不干净的电流声或异常噪音等

请检查本机附近是否有干扰源；若本机更换使用位置后还是有噪音，请联系客服咨询。

- 产品的使用距离受限且声音频繁断续

查看发射器、接收器之间是否有干扰源，将产品更换使用位置再次确认，若声音还是频繁断续，请联系客服咨询。

- 接收器无法多路音轨输出

- ① 检查是否连接了正确的音频线，详情请查看上述“操作指南”。
- ② 检查接收器音轨设置与所用音频线是否对应。若需要四轨输出，在接收器菜单中，音轨数应设置为4轨，音频输出模式应设置为立体声；且通过双头转四头音频线进行连接。
- ③ 若连接仍然异常，请联系客服咨询。

- 降噪功能失效

检查发射器是否设置成了线性输入模式。发射器在线性输入模式下将自动关闭降噪功能。

- 连接电脑后无法读取发射器内存

检查发射器是否开启了板载录音功能。发射器板载录音功能开启时不可读取文件，其余状态下均可读取文件。

- 充电盒无法给发射器/接收器充电

- ① 检查充电触点是否接触不到位，可用干净的布擦拭充电触点后再次进行验证。
- ② 检查磁力是否老化、充电触点是否接触不到位，可通过手按压发射器/接收器验证其能否进入充电状态。若仍然无法充电，请联系客服咨询。
- ③ 检查充电盒是否处于低电量状态。

- 充电盒开盖时无法激活产品自动开机
请先关盖,等待10秒后再重新开盖。若仍然无法激活产品自动开机,请联系客服咨询。

包装清单

Blink500 ProX TXR-WP发射器 ×4
Blink500 ProX 4RX接收器 ×1
Blink500 ProX BOXMAX充电盒 ×1
内置麦克风防风毛套 ×4
领夹麦克风 ×4
USB-A转Type-C充电线 × 1
双头3.5mm TRS转3.5mm TRS相机音频线 ×1
双头3.5mm TRS转3.5mm TRRS手机音频线 ×1
双头3.5mm TRS转四头3.5mm TRS音频线 (SR-C2019) ×1
收纳袋 ×1

其他音频转接线 (单独出售)

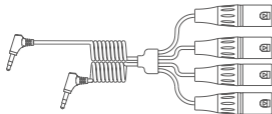

双头3.5mm TRS转四头XLR音频线
(SR-C2020)

参数

Blink500 ProX TXR-WP发射器

传输方式	2.4GHz数字频段
信号调制	数字调制
极性模式	全向型
天线	内置天线
操作范围(无障碍)	最远至280米(在无障碍无干扰空旷环境测得)
射频输出功率	< 10mW
频率响应	20Hz-20kHz
灵敏度	-37dB
信噪比	> 80dB
失真	≤ 0.1%
延时	9.7ms
音频输入	内置麦克风 3.5mm 外接麦克风/线路设备输入
供电方式	内置锂电池供电/ 充电盒触点充电/ Type-C充电口(直流电 5V)
电池容量	400mAh
续航时长	约6.5小时(板载录音开启)
	约11小时(板载录音关闭)
充电时长	约2小时
内存容量	8GB
录音时长	约14小时
录音格式	48KHz/ 24bit, WAV
防尘防水等级	IP67
重量	30.5g
尺寸	56mm×38mm×15.5mm
工作温度	0°C to 50°C
贮存温度	- 10°C to 50°C

Blink500 ProX 4RX接收器

显示屏	OLED
传输方式	2.4GHz数字频段
信号调制	数字调制
天线	内置天线
操作范围(无障碍)	最远至280米(在无障碍无干扰空旷环境测得)
射频输出功率	< 10mW
频率响应	20Hz-20kHz
信噪比	> 80dB
失真	≤ 0.1%
延时	9.7ms
音频输出电平	-5dBu~-66dBu@-40dBu in
音频输出通道	双通道/ 四通道
音频输出模式	单声道/ 立体声
音频输出接口	3.5 mm TRS线性输出孔
监听接口	3.5mm TRS耳机监听孔
供电方式	内置锂电池供电/ 充电盒触点充电/ Type-C充电口(直流电 5V)
电池容量	800mAh
续航时长	约11小时
充电时长	约2小时
重量	56g
尺寸	66mm×49mm×21mm
工作温度	0°C to 50°C
贮存温度	- 10°C to 50°C

Blink500 ProX BOXMAX充电盒

供电方式	Type-C充电口
电池容量	4500mAh
充电盒充电时长	约3小时
给麦克风循环充电次数	1次
重量	343.5g
尺寸	224mm×90mm×38mm
工作温度	0°C to 50°C
贮存温度	- 10°C to 50°C



For better recording experience, the application Saramonic is recommended.

为获得更好的录制体验, 推荐使用枫笛 Saramonic 自主研发应用软件 Saramonic。



Scan the QR code and follow us!
扫描微信二维码关注枫笛公众号!

Shenzhen Jiayz Photo Industrial., Ltd
深圳市长丰影像器材有限公司

A16 Building, Intelligent Terminal Industrial Park of Silicon Valley
Power, Guanlan, Longhua District, Shenzhen, China
深圳市龙华区观澜街道大富工业区硅谷动力智能终端产业园A16栋