

Saramonic®

Sound.Remarkable. 

UHF Wireless Microphone System
无线麦克风系统

UwMic9

User Manual
用户手册

Statement

Please read this manual carefully before using and strictly operate and store in accordance with the instructions. Please save it for your future reference.

If the user manual can not help you to solve certain problems, please ask your retailer for help or email us: **info@saramonic.com**.

Cautions

1. Do not use the unit under water, don't expose it to rain. Please store it in a cool, dry place.
2. Please use and store it in normal temperature. Do not move it from overheated to supercooled condition frequently as well as keep away from heat sources such as heater and oven.
3. When using and storing, please pay attention to dust and moisture.
4. Be careful to violent collision.
5. To avoid acoustical feed-back, do not hold the microphone close to the loudspeakers.
6. For the best sound pick-up pattern do not hold your hand against the microphone head.
7. Remove the batteries from the battery compartment when the device is not used for a long time.

Contents

General Introduction	2
Portable Receiver UwMic9-RX9	2
Introduction	2
Product Structure	2
Attaching Accessories	4
LCD Display Operation Guide	5
Body-pack Transmitter UwMic9-TX9	9
Introduction	9
Product Structure	9
Attaching Accessories	10
LCD Display Operation Guide	11
Hand-held Microphone UwMic9-HU9	14
Introduction	14
Product Structure	14
Setup Guide	15
Plug-on Transmitter UwMic9-TX-XLR9	16
Introduction	16
Product Structure	16
Attaching Accessories	17
LCD Display Operation Guide	18
Plug-on Receiver UwMic9 RX-XLR9	21
Introduction	21
Product Structure	21
Attaching Accessories	23
LCD Display Operation Guide	23
UwMic9 SP-RX9	26
Product Structure	26
Introduction	26
LCD Display Operation Guide	28
Operation Guide	32
Specification	37
Receiver RX9 and RX-XLR9	37
Transmitter TX9, HU9 and TX-XLR9	38
Receiver SP-RX9	38
Packing list	40

General Introduction

The Saramonic UwMic9 UHF wireless microphone system is intended for portable wireless operation and can be used in several environments for applications such as DSLR video, field recording, broadcast TV, electronic news gathering (ENG), on-the-spot interviews, and more.

Portable Receiver UwMic9-RX9

Introduction

The Saramonic UwMic9-RX9 is a camera-mountable integrated wireless receiver. It features a wide switching RF bandwidth, an easy-to-read LCD display and infrared synchronization between transmitter and receiver.

Equipped with an auto-scan function, the RX9 can automatically search for an available transmission frequency.

The selectable output mode allows you to choose the output signal to be mono or stereo.

Product Structure

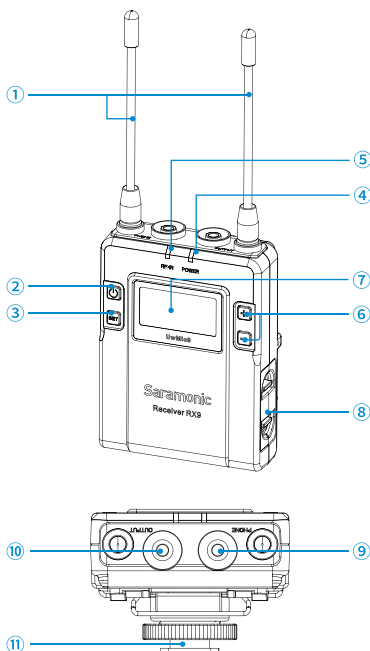

- ① **Antennas**
 - ② **Power button**
Long Press to turn on or off the RX9.
 - ③ **SET button**
Long press the SET button to enter the displayed menu. Then, short press the SET button to confirm your option or long press again to exit without saving.
 - ④ **POWER indicator**
Indicates the battery level as follows:
Green light: Sufficient battery level.
Red light: Low battery level.
 - ⑤ **RF indicator and infrared transmitter port**
The infrared transmitter port sends the set frequency to a transmitter.
RF indicator displays the RF input level as follows:
Green light: RF signal is strong.
Red light: RF signal is weak or disconnected.
 - ⑥ **+ or - button**
Selects functions or values shown on the display.
 - ⑦ **LCD display**
Display menus, please refer to "LCD Display Operation Guide" (page 5) for more details.
 - ⑧ **Battery compartment**
Operates on two AA batteries (not included).
 - ⑨ **Phone jack**
It is a 3.5mm diameter and stereo mini headphone jack.
Connect a headphone to monitor the audio output
- Note:** Please do not connect a headphone with a monaural mini jack. As this may short-circuit the headphone jack and distorted sound output.
- ⑩ **Output jack**
Connect the RX9 to a video camera, camcorder, mixer or amplifier with the supplied output cable.
 - ⑪ **Standard cold shoe**

Attaching Accessories

Connect the supplied cable to the output jack.

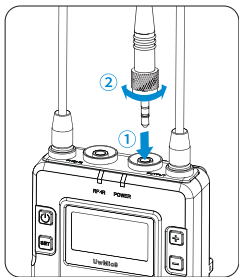

- ① Plug the supplied cable into the OUTPUT jack.
- ② For a secure connection, turn to lock the connector.

Attach a belt clip. Please Refer to "Attaching Accessories" (page 11).

Attach the shoe mount adapter.

- ① Please attach the belt clip upside-down before attaching the shoe mount adapter.
- ② Push the bottom of the belt clip to make some space between the belt clip and the receiver.
- ③ Align the belt clip with the two vertical grooves on the shoe mount adapter and insert the adapter in the direction of the arrow.
- ④ Push the shoe mount adapter in fully until the belt clip fits into the horizontal groove on the adapter holds.

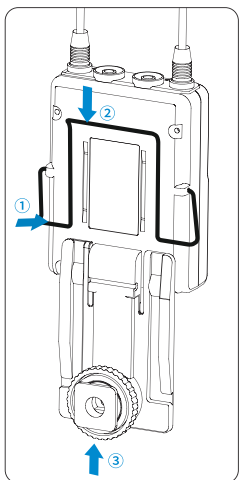

LCD Display Operation Guide

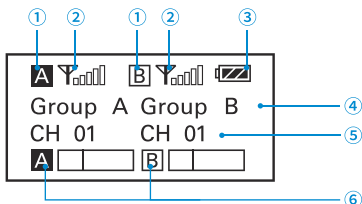

Home screen. If no operation is performed for 20 seconds on the other screens, the display will automatically return to the home screen.

- ① Group icon
 - Indicates the power of group A is turned off.
 - Indicates the power of group A is turned on.
- ② RF level indicator
Indicates the current reception level.
- ③ Battery level indicator
Displays the battery level. Please replace both batteries immediately when the indicator starts flashing.
- ④ Name of the channel group
- ⑤ Current channel
Displays the current channel number.
- ⑥ Audio input level meter
Displays the audio input level.

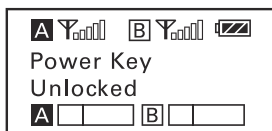

Power key. Long press the SET button to unlocked or locked the power key. Lock the power key to prevent the receiver being turned off unwittingly while using.

- **Unlocked:** Long press the power key to turn the receiver on or off (System default).
- **Locked:** The receiver will not be turned off even after pressing the power key.

Note: If the batteries are removed and reinserted while the power key is set to Locked, the lock state of the Power key will not be changed. You can turn on the receiver by long pressing the power button.

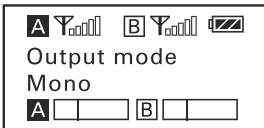

Output mode. The output mode can be selected to mono or stereo. When the output mode is mono, the audio from left and right channel will be mixed. When it is stereo, the left (Group B) and right (Group A) audio channel output will be separated. System default is mono.

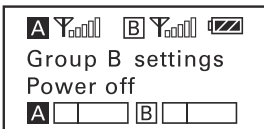
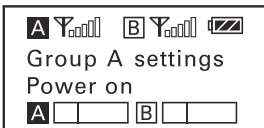

Power of the Group. When you only use one group signal, please turn off the other group to save battery. To save battery, system default of the Group B is power off while the Group A is power on.

When operating two transmitters simultaneously, please set each transmitter to a different group to prevent interference or noise.

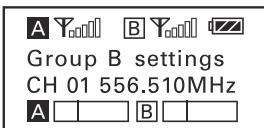
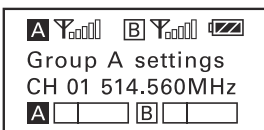

Select channel. Details of operation, please refer to "Manually setting the receiver channel" (page 35).

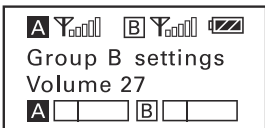
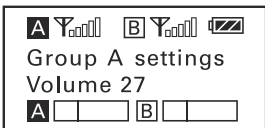

Set output volume. Set the volume of output audio within the range 0 to 30. The setting is retained even after the power is turned off. Default is 27.

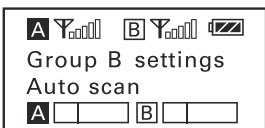
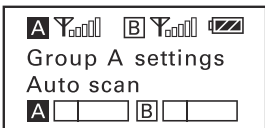

Auto scan function. Automatically scan an available and clear channel. Details of operation, please refer to "Using the auto scan function" (page 34).

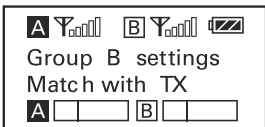
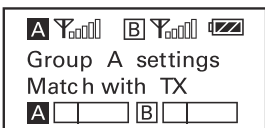

Infrared matching function. Match the receiver and transmitter via infrared. Details of operation, please refer to "Match the channel of receiver and transmitter" (page 35).

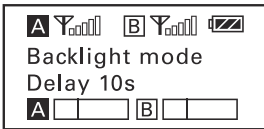

Set backlight. Set the background LED light to ON or Delay 60 /30 /10 seconds or OFF. Default is "Delay 10s."

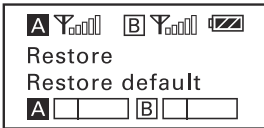

Restore default setting.

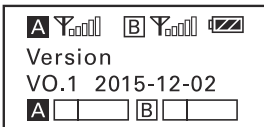

Version of the UwMic-RX9.

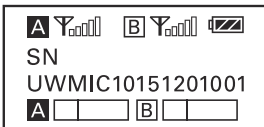

Serial Number.

Body-pack Transmitter UwMic9-TX9

Introduction

This transmitter is a compact transmitter that employs a crystal-controlled PLL synthesizer. It is equipped with a muting function and a locking-type microphone input connector. The RF power output can be switched among high, middle and low.

Product Structure

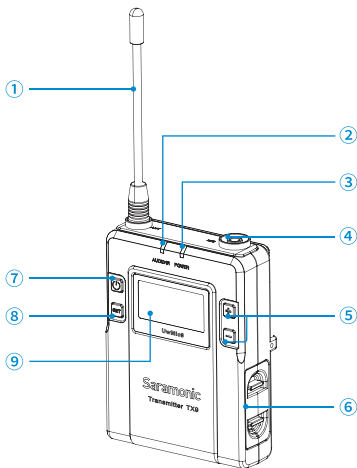

- ① **Antenna**
- ② **AUDIO indicator / IR (infrared detector)**
 AUDIO indicator: Indicates the audio input level.
 IR (infrared detector): Receives the frequency from the receiver.
 Solid Green: Audio input level is appropriate.
 Flashing Red: Audio is muted (i.e., disabled).
 For details on setting the mute function, please refer to "Set Mute key" (page 13).
- ③ **POWER indicator**
 Indicates the battery level as follows:
 Solid Green: Sufficient battery level.
 Solid Red: Low battery.
- ④ **Audio input connector (3.5mm locking-type plug)**
 Connect to the supplied lavalier microphone.
- ⑤ **+ or - button**
 Selects functions or values shown on the display.

⑥ **Battery compartment**

Accepts two AA batteries (alkaline, nickel metal hydride, or lithium batteries).

⑦ **Power / Mute button**

Function	Operation
Power ON	Press button for one second or longer
Power OFF	Press button until it turns off
Mute ON	Short press button
Mute OFF	

⑧ **SET button**

Long press the SET button to enter the displayed menu. Then, short press the SET button to confirm your option or long press again to exit without saving.

⑨ **LCD display**

Display menus, please refer to "LCD Display Operation Guide" (page 11) for more details.

Attaching Accessories

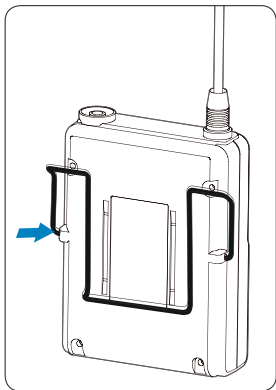

1. Attach a belt clip

Insert one end of the belt clip into one of two holes on either side of the transmitter, and then insert the other end into the hole on the other side.

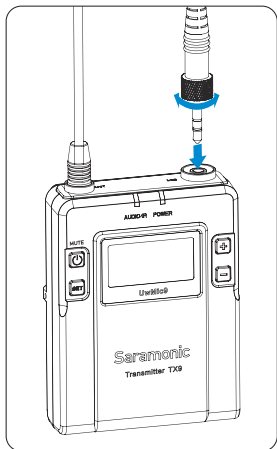

2. Connect the microphone



For a secure connection, turn to lock the connector.

Note: Please turn off the transmitter before attaching or removing the microphone.

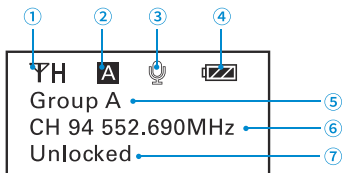
LCD Display Operation Guide



Home screen. If no operation is performed for 20 seconds on the other screens, the display will automatically return to the home screen.

- ① RF transmission power indicator
Indicates the current transmission power level.
For details on setting the level, please see "Select RF power level" (page 12).
- ② Channel group indicator
Indicates the channel group.
- ③ Mute indicator
 Mute OFF
  Mute ON
- ④ Battery level indicator
Displays the battery level. Please replace both batteries immediately when the indicator starts flashing.

- ⑤ Name of the channel group
- ⑥ Channel and frequency
Indicate the current channel and frequency.
- ⑦ The status of Power / Mute button.

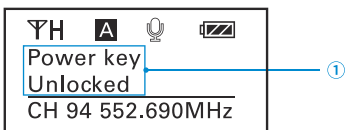

- ① Menu display section. Displays various functions. Press the + or - button to switch functions.

Set Power key. Select Unlocked or Locked.

Set "Locked" to lock the power button to prevent the unit being turned off or muted unwittingly while using. Default is "Unlocked."



Select Channel. Long press the SET button to enter the menu. Use the "+" and "-" to select the channel you need and short press the SET button to confirm.



Select Group. You can choose "A" or "B" channel group. Each group has 96 channels. Default is 'Group A.'



Select RF power level. You can set the transmitted RF power to High, Middle or Low. Default is "High."





 Mute key setting
Enable
 CH 94 552.690MHz

Set Mute key. If you want to mute the audio, please select "Enable" first and then short press the power button. Default is "Enable."





 IR Match
Match with RX
 CH 94 552.690MHz

IR Match. Set to match with the receiver. The screen will display "Matching" when in process. After successful matching, it will indicate "Sync finished."





 Backlight mode
Delay 10s
 CH 94 552.690MHz

Set Backlight. Select ON, OFF or Delay 10 / 30 /60 seconds. Default is "Delay 10s."





 Restore
Restore default
 CH 94 552.690MHz





Restore default setting.





 Version
VO. 1 2015-12-02
 CH 94 552.690MHz

Version of the UwMic9-TX9.





 SN
UWMIC10151201001
 CH 94 552.690MHz

Serial Number.

Hand-held Microphone UwMic9-HU9

Introduction

Saramonic HU9 is a handheld wireless UHF microphone transmitter features a compact metallic body, an easy-to-read LCD display, a RF power switch and a PLL synthesizer. The broadcast quality microphone will capture crystal clear and rich sound. It has a built-in antenna, a muting function and power lock function. The channel of HU9 is synced up with the receiver via infrared.

Product Structure

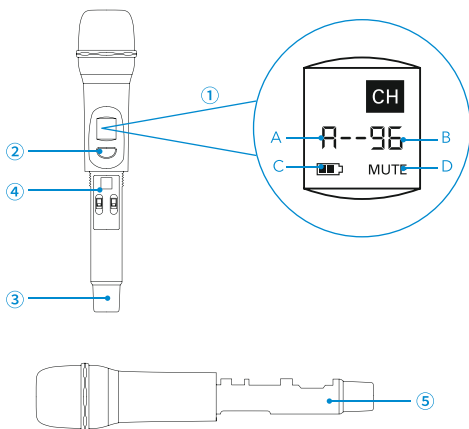

① LCD screen

A. Channel Groups.

Two channel groups: A and B. Each group has 96 channels.

B. Channel number.

C. Battery level indicator.

D. MUTE. Audio is muted.

This LCD display indicates it is operating on channel 96 of group A.

② Power / Mute button

Power: Long press to turn on/off the HU9.

Mute: Short press the button while transmitting, the audio will be muted. Press it again to restore the audio output.

Note: In muting, the audio signal is not output but an RF signal is still transmitted.

- ③ Antenna
- ④ Operation panel

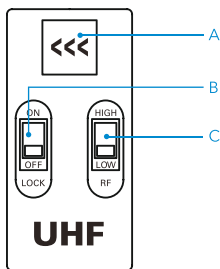

- A. Infrared detector. Receives the frequency set on the receiver.
- B. Lock switch. Set to ON will lock the power button. It will prevent the power being turned off inadvertently during transmission.

Note: The lock switch will not lock the mute function.

- C. RF power. Set the transmit output level to HIGH or LOW.

⑤ Battery compartment

Operates on two AA batteries (not included). You could use alkaline, lithium or nickel metal hydride batteries.

Setup Guide

1. Install the batteries. Refer to "UwMic9-HU9" (page 33).
2. (Option) Set the lock switch to ON or OFF.
3. (Option) Set the RF power to HIGH or LOW. The transmit power level varies depending on the model.
4. Press the power button to turn on the HU9.
5. Turn on the receiver UwMic9-RX9 and sync with the transmitter HU9. Details of operation, please refer to "For HU9" (page 36).
6. When sync successfully, the screen of HU9 will show the group and channel same as the receiver.
7. Close the grip in the direction of the arrows.

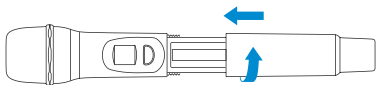

8. Now it is ready to use.

Plug-on Transmitter UwMic9-TX-XLR9

Introduction

The Saramonic TX-XLR9 is a compact XLR plug-on type transmitter. It features a wide switching RF bandwidth, an easy-to-read LCD display, +48V phantom power and mute function. It is suitable for portable wireless operation and can be used in a wide range of applications such as DSLR video, broadcast TV, ENG and more.

Product Structure

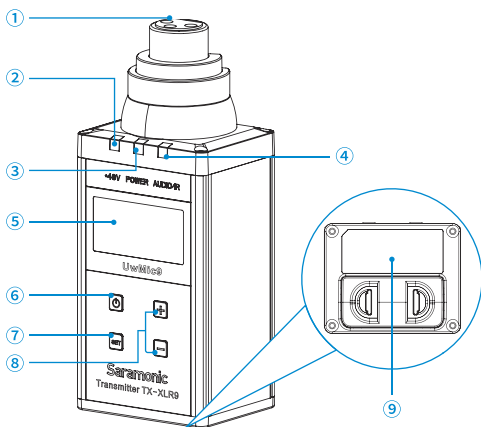

- ① **XLR audio input jack**
Connects to an XLR microphone or audio devices with line output.
- ② **+48V power indicator**
Lights up when the +48V phantom power is on.
- ③ **POWER indicator**
Indicates the battery level as follows:
Solid Green: Sufficient battery level.
Solid Red: Low battery.
- ④ **AUDIO indicator / IR (infrared detector)**
AUDIO indicator: Indicates the audio input level.
IR (infrared detector): Gets the frequency from the receiver.
Solid Green: Audio input level is appropriate.
Flashing Red: Audio is muted (i.e., disabled). For details on setting the mute function, please refer to "Set Mute key" (page 20).

- ⑤ **LCD screen**
Displays menus, please refer to "LCD Display Operation Guide" (page 18) for more details.
- ⑥ **Power / Mute button**
Turns the power or mute function to on or off.

Function	Operation
Power ON	Press the button for one second or longer
Power OFF	Press the button until it turns off
Mute ON	Short press the button
Mute OFF	

- ⑦ **SET button**
Long press the SET button to enter the displayed menu. Then short press the SET button to confirm your option or long press again to exit without saving.
- ⑧ **+ or - button**
Selects functions or values shown on the display.
- ⑨ **Battery Compartment**
Operates on two AA batteries (alkaline, nickel metal hydride, or lithium batteries). For details on how to insert batteries, please refer to "Install the batteries" (page 32).

Attaching Accessories

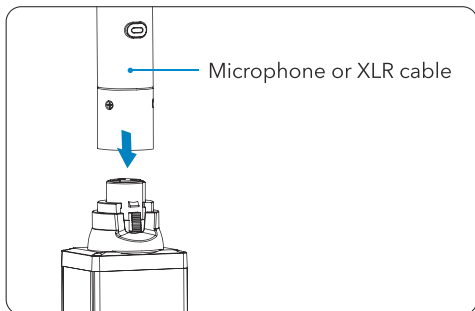

1. Attach a microphone or XLR cable.

Push the microphone or cable connector into the XLR audio input jack of the TX-XLR9 until it clicks into place.

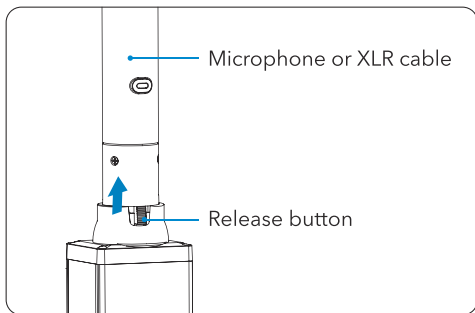

2. Disconnect a microphone or XLR cable.



Press the release button and pull the microphone or XLR cable out carefully in the direction of arrow.

Note: Please turn off the transmitter before attaching or removing the microphone.

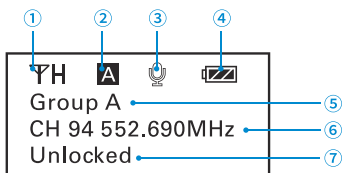
LCD Display Operation Guide



Home screen. If no operation is performed for 20 seconds on the other screens, the display will automatically return to the home screen.

- ① **RF transmission power indicator**
Indicates the current transmission power level.
For details on setting the level, please see "Select RF power level" (page 20).
- ② **Channel group indicator**
Indicates the channel group.
- ③ **Mute indicator**
 Mute OFF  Mute ON
- ④ **Battery level indicator**
Displays the battery level. Please replace both batteries immediately when the indicator starts flashing.
- ⑤ **Name of the channel group**
- ⑥ **Channel and frequency**
Indicate the current channel and frequency.
- ⑦ **The status of Power / Mute button**

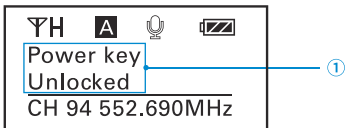

- ① Menu display section. Displays various functions. Press the + or - button to switch functions.

Set Power key. Select Unlocked or Locked.

Set "Locked" to lock the power button to prevent the unit being turned off or muted unwittingly while using. Default is "Unlocked."



Select Channel. Long press the SET button to enter the menu. Use the "+" and "-" to select the channel you need and short press the SET button to confirm.



Select Group. You can choose "A" or "B" channel group. Each group has 96 channels. Default is "Group A."



Set the microphone drive power supply (+48V). When set to ON, 48V phantom power is supplied to the connected microphone and the "+48V" indicator lights up. Default is "+48V OFF."

Note: Please DO NOT turn on the phantom power when using with microphones that do not operate on phantom power, mixing boards or any unbalanced devices, because it may cause damage to both transmitter and audio device.



Select RF power level. You can set the transmitted RF power to High, Middle or Low. Default is "High."



Set Mute key. If you want to mute the audio, please select "Enable" first and then short press the power button. Default is "Enable."



IR Match. Set to match with the receiver. The screen will display "Matching" when in process. After successful matching, it will indicate "Sync finished."



Set Backlight. Select ON, OFF or Delay 10 / 30 /60 seconds. Default is "Delay 10s."



Restore default setting.



Version of the UwMic9-TX-XLR9.



Serial Number.

Plug-on Receiver UwMic9 RX-XLR9

Introduction

The Saramonic UwMic9 RX-XLR9 is a compact XLR plug-on wireless receiver. It plugs directly into a video camera or recorder's XLR microphone input without getting in the way of other accessories. The XLR connector rotates both clockwise and counter clockwise.

The receiver can be powered by two AA batteries or DC power via the USB Type-C jack. It features a wide switching RF bandwidth, an easy-to-read LCD screen, a 3.5mm headphone jack and infrared synchronization between transmitter and receiver.

Product Structure

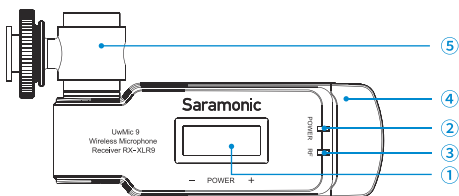

① LCD display

Display menus, please refer to "LCD Display Operation Guide" (page 23) for more details.

② Power indicator

Indicates the battery level as follows:

Green light: Sufficient battery level.

Red light: Low battery level.

③ RF indicator and infrared transmitter port

The infrared transmitter port sends the set frequency to a transmitter.

RF indicator displays the RF input level as follows:

Green light: RF signal is strong.

Red light: RF signal is weak or disconnected.

④ Antenna

⑤ Rotatable XLR-3-11C type (male) connector

Connects the receiver to a camera or recorder's XLR mic input. The receiver can be rotated by a maximum angle of 320°.

⑥ Phone jack

It is a 3.5mm diameter and stereo mini headphone jack. Connect a headphone to monitor the audio output.

Note: Please do not connect a headphone with a monaural mini jack. As this may short-circuit the headphone jack and distorted sound output.

⑦ + or - button

Selects functions or values shown on the display. Long press the "-" button to enter the displayed menu.

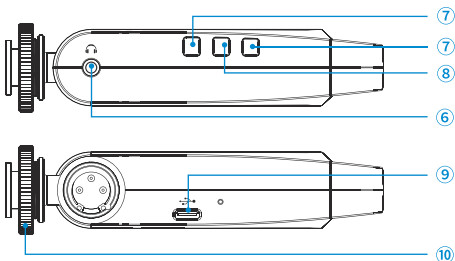

⑧ Power button

Long press to turn on or off the receiver. Short press the power button to confirm your option.

⑨ USB connector (Type-C)

When a USB portable power supply is connected while the receiver is turned on, it automatically operates with the power supplied by the USB portable power, no matter AA batteries are inserted or not.

When a USB portable power supply is connected while the receiver is turned off, it automatically turns on.

Note: When the USB portable power supply is loosen and unconnected, the receiver will be powered by AA batteries automatically, but if no AA batteries were inserted, it will be turned off.

⑩ Standard cold shoe

Attaching Accessories

To mount the receiver to a video camera, proceed as follows:

1. Slide the cold shoe mount onto the hot shoe of the DSLR camera as shown, and fasten the cold shoe mount using the locking screw.

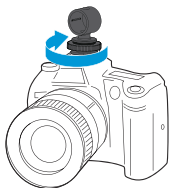

2. Plug the receiver's rotatable XLR connector into the cold shoe adapter.
3. Connect the receiver to the mic jack of the camera with the supplied XLR to 3.5mm audio cable.

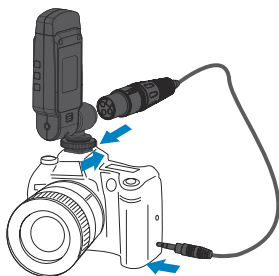

LCD Display Operation Guide

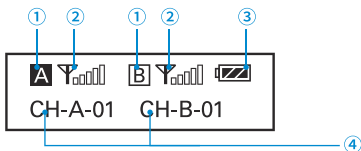

Home screen. If no operation is performed for 20 seconds on the other screens, the display will automatically return to the home screen.

- ① Group icon

A Indicates the power of group A is turned off.

A Indicates the power of group A is turned on.

- ② RF level indicator
Indicates the current reception level.
- ③ Battery level indicator
Displays the battery level. Please replace both batteries immediately when the indicator starts flashing.
- ④ Channel group and channel number
Displays the current channel number in Group A and Group B. "CH-A-01" means the Group A is in channel 01 now.



Power key. Long press the "-" button to enter the displayed menu. Use the "+" or "-" button to select locked or unlocked the power key and confirm it by pressing the POWER button. Lock the power key to prevent the receiver being turned off unwittingly while using.

Unlocked: Long press the power key to turn the receiver on or off (System default).

Locked: The receiver will not be turned off even after pressing the power key.

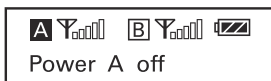
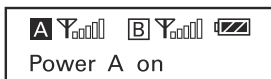

Power of the Group. When you only use one group signal, please turn off the other group to save battery. System default of the Group B is power off while the Group A is power on. When operating two transmitters simultaneously, please set each transmitter to a different group to prevent interference or noise.

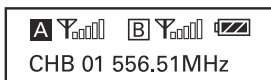
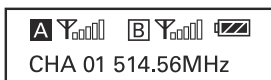

Select channel. Long press the "-" button to enter the displayed menu. Use the "+" or "-" button to select the desired channel and confirm it by pressing the POWER button.

Default is Group A in Channel 01 (514.56MHz) and Group B in Channel 01 (556.51MHz).

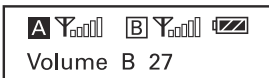
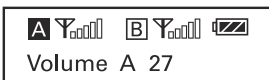

Set output volume. Set the volume of output audio within the range 0 to 30. The setting is retained even after the power is turned off. Default is 27.

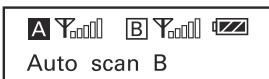
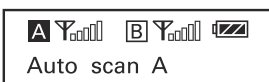

Auto scan function. Automatically scan an available and clear channel. Details of operation, please refer to "Using the auto scan function" (page 34).

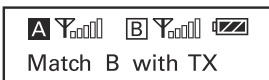
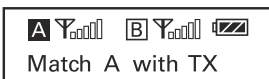

Infrared matching function. Match the receiver and transmitter via infrared. Details of operation, please refer to "Match the channel of receiver and transmitter" (page 35).



Set backlight. Set the background LED light to ON or Delay 60 /30 /10 seconds or OFF. Default is "Delay 10s."

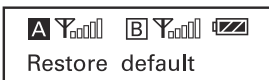

Restore default setting.



V1.0 Rel. 826001A

Version of the UwMic RX-XLR9.



XLRRX09000000000

Serial number.

UwMic9 SP-RX9

Introduction

The SP-RX9 is a compact two-channel wireless receiver and mixer, ideal for making videos with iOS or Android mobile devices and cameras. It can be used when paired with transmitters in UwMic9 system to capture audio. Meanwhile, it is an independent audio mixer that has three inputs available.

With built-in li-on battery, the receiver can be also powered by DC power via the USB Type-C connector. It comes with an aluminum handgrip for recording on the move, or it can be mounted on a tripod for stationary use. The standard shoe mount on the top of the receiver is suitable for attaching accessories.

Product Structure

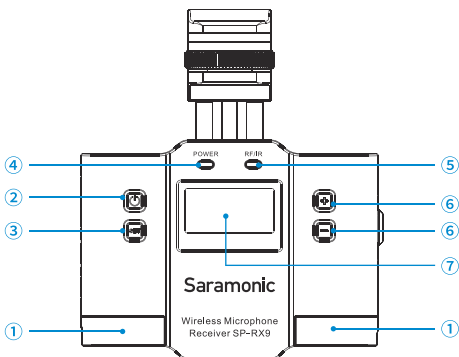

- ① **Antennas**
- ② **Power button**
Long Press to turn on or off the SP-RX9.
- ③ **SET button**
Long press the SET button to enter the displayed menu. Then, short press the SET button to confirm your option or long press again to exit without saving.
- ④ **POWER indicator**
Indicates the battery level as follows:
Green light: Sufficient battery level.
Red light: Low battery level.
- ⑤ **RF indicator and infrared transmitter port**
The infrared transmitter port sends the set frequency to a transmitter.
RF indicator displays the RF input level as follows:
Green light: RF signal is strong.
Red light: RF signal is weak or disconnected.
- ⑥ **+ or - button**
Selects functions or values shown on the display.
- ⑦ **LCD display**
Display menus, please refer to "LCD Display Operation Guide" (page 28) for more details.

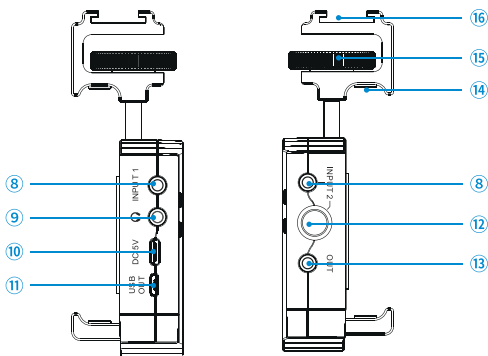

- ⑧ **3.5mm microphone inputs**
- ⑨ **Phone jack**
It is a 3.5mm diameter and stereo mini headphone jack. Connect a headphone to monitor the audio output.

Note: Please do not connect a headphone with a monaural mini jack. As this may short-circuit the headphone jack and distorted sound output.

- ⑩ **USB connector (Type-C)**

⑪ **Output jack (Micro USB)**

Connect the receiver to an iOS device with lightning input or an Android mobile device with Type-C connector.

⑫ **Mini XLR microphone input**

⑬ **Output jack (3.5mm)**

Connect the receiver to an iOS, Android mobile device or camera with a 3.5mm input.

⑭ **Device holder**

Adjustable phone holder

⑮ **Thumb screw**

⑯ **Standard cold shoe mount**



⑰ **Hand grip**

LCD Display Operation Guide

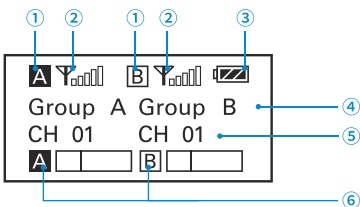

Home screen. If no operation is performed for 20 seconds on the other screens, the display will automatically return to the home screen.

① **Group icon**

A Indicates the power of group A is turned off.

A Indicates the power of group A is turned on.

② **RF level indicator**

Indicates the current reception level.

③ **Battery level indicator**

Displays the battery level. Please charge the receiver immediately when the indicator starts flashing.

④ **Name of the channel group**

⑤ **Current channel**

Displays the current channel number.

⑥ **Audio input level meter**

Displays the audio input level.

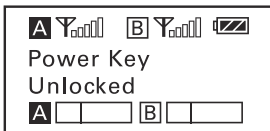

Power key. Long press the SET button to unlocked or locked the power key. Lock the power key to prevent the receiver being turned off unwittingly while using.

- **Unlocked:** Long press the power key to turn the receiver on or off (System default).
- **Locked:** The receiver will not be turned off even after pressing the power key.

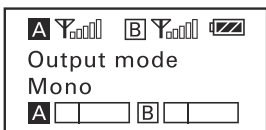

Output mode. The output mode can be selected to mono or stereo. When the output mode is mono, the audio from left and right channel will be mixed.

When it is stereo, the audio will be separated into left and right channel. The wireless transmitter microphone on Group A and the audio from INPUT 1 will be on left channel. System default is mono.

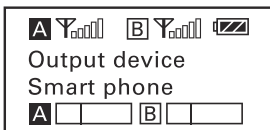

Output device. The output device can be selected to smart phone or camera. System default is smart phone. Remember to change it to "camera" when connecting the SP-RX9 to a video camera or camcorder.

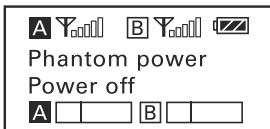

48V Phantom power. Long press the SET button to turn on the 48V phantom power if the XLR microphone requires power supply. System default is power off.

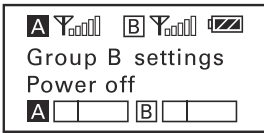
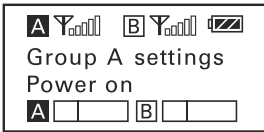

Power of the Group. When you only use one group signal, please turn off the other group to save battery. To save battery, system default of the Group B is power off while the Group A is power on.

When operating two transmitters simultaneously, please set each transmitter to a different group to prevent interference or noise.

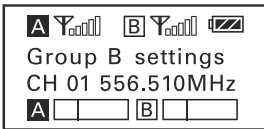
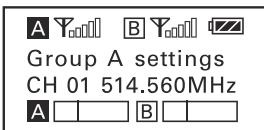

Select channel. Details of operation, please refer to "Manually setting the receiver channel" (page 35).

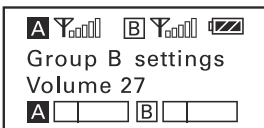
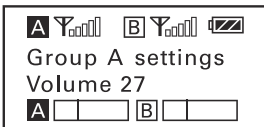

Set output volume. Set the volume of output audio within the range 0 to 30. The setting is retained even after the power is turned off. Default is 27.

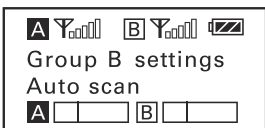
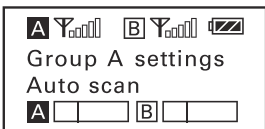

Auto scan function. Automatically scan an available and clear channel. Details of operation, please refer to "Using the auto scan function" (page 34).

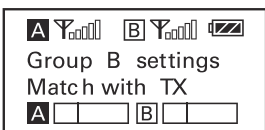
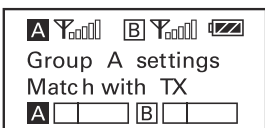

Infrared matching function. Match the receiver and transmitter via infrared. Details of operation, please refer to "Match the channel of receiver and transmitter" (page 35).

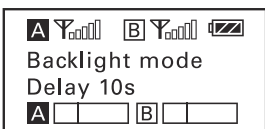

Set backlight. Set the background LED light to ON or Delay 60 /30 /10 seconds or OFF. Default is "Delay 10s."

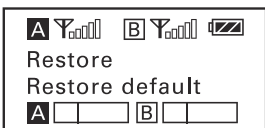

Restore default setting.

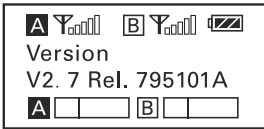

Version number of the receiver.

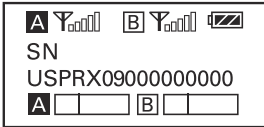

Serial Number.

Operation Guide

1. Install the batteries

① UwMic9-RX9 and UwMic9-TX9. Batteries can be inserted in the plug-on transmitter UwMic9-TX-XLR9 in the same manner.

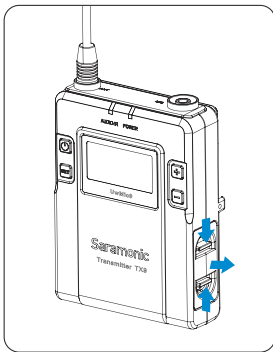

- Long press the Power key to turn the unit off.
- Slide the two catches inward and pull out the battery compartment.
- Insert two AA size batteries according to the polarity indicators and close the compartment. Please be sure the battery compartment is locked securely.

② UwMic9-HU9

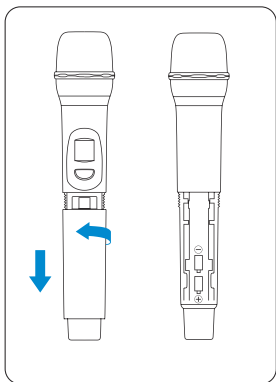

- Long press the power button to turn the power off.
- Turn the grip in the direction of the arrow, and pull the grip down until the battery compartment is visible.
- Insert two new AA batteries into the battery compartment with \oplus and \ominus polarities in the correct orientation.

③ UwMic9 RX-XLR9

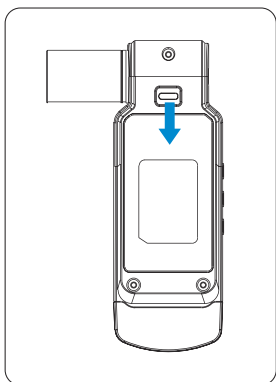

- Long press the power button turn the unit off.
- Gently slide out the battery cover by pushing the button as shown.
- Insert two new AA batteries into the battery compartment with the polarities in correct orientation.

Note:

- ① Please remove the batteries from the battery compartment when the device is not used for a long time.
- ② Please always use sets of the same type of battery.
- ③ Replacing the batteries during operation may generate noise. Please make sure that the unit is turned off before replacing batteries.

2. Connect the receiver to the mic jack of a camera, camcorder or mixer with the supplied cable.

3. Turn on the receiver by long pressing the power button.

4. Set the channel of the receiver by two ways:

- ① Using the auto scan function

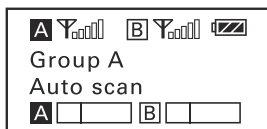

Use the + or - button to display the auto scan screen on the receiver.

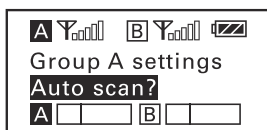

Long press the SET button to select "Auto scan?"

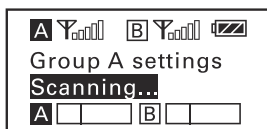

Press the SET button to confirm.

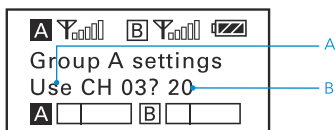

The channel with the least noise and interference will be displayed.

A. Indicates the current least noise channel is CH 03 and ask you if you would like to use it. You can short press the SET button to confirm the channel within 20 seconds or long press the SET button to exit the displayed menu without saving.

B. Counting down 20 second

Note:

- ① After 20 seconds have elapsed, the display returns to the home screen without saving.
- ② Some noise may occur when power is turned on, you could turn down the audio input level of devices connected to the receiver accordingly.

② Manually setting the receiver channel.

- Use the + or - button to display the channel menu on the receiver.

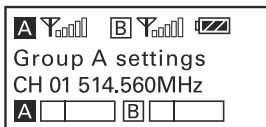

- Long press the SET button to select the menu.

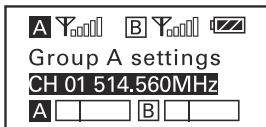

- Use the + or - button to select the desired channel and confirm it by short pressing the SET button.

5. Match the channel of receiver and transmitter.

① Using infrared transmission to transfer the frequency set on the receiver to a transmitter.

For the TX9 and TX-XLR9

- Turn on the transmitter and receiver.
- Use the + or - button to display the "Match with TX" menu on receiver.

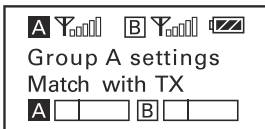

- Use the + or - button to display the "Match with RX" menu on transmitter.



- Both long press the SET button to select the menu and short press it to confirm.
- Place the infrared transmitter port on the receiver near the infrared detector on the transmitter.
- If "Sync finished!" displayed on the LCD screen, the frequency for use on the transmitter is set.
- After matching successfully, press the SET button of receiver to return to the previous menu.

For HU9

- Turn the transmitter power on.
- Use the + or - button to display the "Match with TX" menu on receiver.

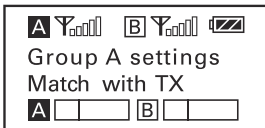

- Place the infrared transmitter port on the receiver near the infrared detector on the transmitter.
- If sync successfully, the group and channel of HU9 are the same as the receiver's.
- After matching successfully, press the SET button of receiver to return to the previous menu.

Note: When using the infrared link, please place the receiver and transmitter within about 20cm of each other within 20 seconds. After 20 seconds have elapsed, the infrared transmission finishes and the display returns to the previous menu.

- ② Manually setting the transmitter channel (Only available on the UwMic9-TX9 and the UwMic9-TX-XLR9).

- Turn on the transmitter by long pressing the power button.
- Use the + or - button to display the channel setting menu on the transmitter.



- Long press the SET button to select the menu.
- Use the + or - button to select the same channel as the receiver and confirm it by short pressing the SET button.

6. Attach the accessories you need for the receiver and transmitter. Refer to "Attaching Accessories" (page 4, page 10, page 17 and page 23).

7. You are ready to record.

Specification

Receiver RX9 and RX-XLR9

Channel number	96
Channel group	A and B
Oscillator type	PLL synthesizer
Audio output connector	RX9: 3.5 mm mini jack RX-XLR9: XLR-3-11C type (male)
Antenna	1/4λ wire antenna
Audio output level	-60 dBV
Headphone output level	30mW (16 Ω)
Receive frequencies	514 MHz - 596 MHz
Receive sensitivity	-95 dBm
Signal to noise ratio	70 dB or more
Voice delay	12 ms
Reference deviation	±5 kHz (-60 dBV, 1 kHz input)
Frequency response	40 Hz to 18 kHz (+/-3dB)
Distortion	0.5% or less
Spur suppression	-60 dB
Reference audio input level	-60 dBV (MIC input, 0 dB attenuation)
Weight (excluding batteries)	RX9: Approx. 218.7g RX-XLR9: Approx. 96g
Battery	Two AA size batteries
DC input connector	Type-C jack (RX-XLR9 only)

Dimensions	RX9: 170.9 × 63.5 × 30.0 mm
	RX-XLR9: 112 × 63 × 26 mm
Operating temperature	0 °C to 50 °C
Storage temperature	-20 °C to +55°C

Transmitter TX9, HU9 and TX-XLR9

Channel number	96
Channel group	A or B
Oscillator type	PLL synthesizer
Carrier frequencies	514 MHz - 596 MHz
Reference deviation	±5 kHz (-60 dBV, 1 kHz input)
Signal to noise ratio	70 dB or more
Spur suppression	-60 dB
Voice delay	12 ms
Antenna	1/4λ wire antenna
Audio input connector	TX9: 3.5mm mini jack
	HU9: none
	TX-XLR9: XLR-3-11C type (female)
Reference audio input level	-60 dBV (MIC input, 0 dB attenuation)
Distortion	0.5% or less
Weight	TX9: Approx. 211.4g (excluding batteries)
	HU9: Approx. 338.2g (excluding batteries)
	TX-XLR9: Approx. 138g (Excluding batteries)
Battery	Two AA size batteries
Dimensions	TX9: 170.9 × 63.5 × 30.0 mm
	HU9: 254.0 × 52.0 × 52.0 mm
	TX-XLR9: 105.5 × 43 × 34.7 mm
Operating temperature	0°C to 50°C
Storage temperature	-20°C to +55°C

Receiver SP-RX9

Channel number	96
Channel group	A or B
Oscillator type	PLL synthesizer
Receive frequencies	514 MHz - 596 MHz
Audio input connector	Two 3.5 mm mini jacks and one mini XLR jack
Audio output connector	One 3.5 mm mini jack and one Micro USB
Headphone output connector	3.5 mm mini jack
INPUT 1 gain	20 dB

INPUT 2 & mini XLR gain	20 dB
Micro USB gain	20 dB
INPUT 1 & INPUT 2 power	5V power supplies
Mini XLR jack phantom power	48V power supplies
Antenna	Built-in 1/4λ wire antenna
Audio output level	-60 dBV
Headphone output level	30 mW (16 Ω)
Receive sensitivity	-95 dBm
Signal to noise ratio	70 dB or more
Voice delay	12 ms
Reference deviation	±5 kHz (-60 dBV, 1 kHz input)
Frequency response	40 Hz to 18 kHz (+/-3 dB)
Distortion	0.5% or less
Spur suppression	-60 dB
Battery	Built-in Li-ion battery (1200 mA)
Power	DC 5V (USB Type-C)
Dimensions	100.0 × 38.6 × 259.6 mm (Including the hand grip)
Device holder width	66.4 mm to 84.1 mm (2.6" to 3.3")
Weight	Approx. 433 g (Including the hand grip)
Operating temperature	0 °C to 50 °C
Storage temperature	-20 °C to +55°C

Packing list

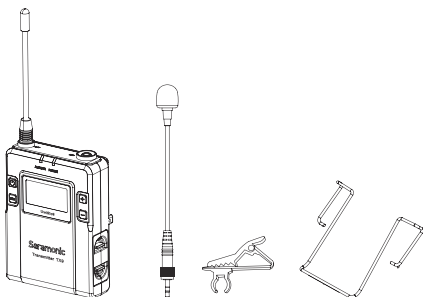

TX9

- Body-pack transmitter: TX9
- Omni-directional lavalier microphone
- Microphone holder clip
- Wind screen
- Belt clip

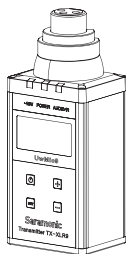

TX-XLR9

- Plug-on transmitter: TX-XLR9

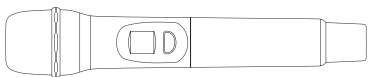

HU9

- Hand-held microphone: HU9

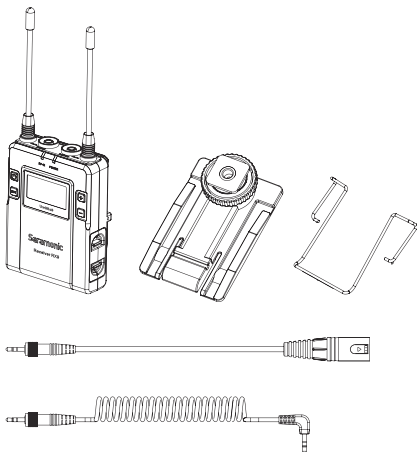

RX9

- Portable receiver: RX9
- Shoe mount adapter
- Belt clip
- XLR to 3.5mm locking-type plug audio output cable
- 3.5mm locking-type plug audio cable

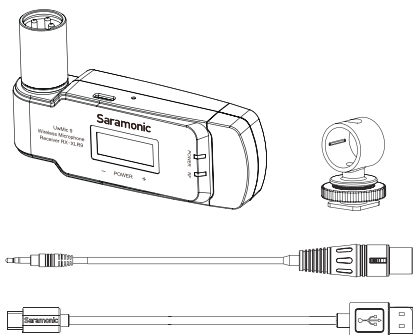

RX-XLR9

- Plug-on receiver: RX-XLR9
- Shoe mount adapter
- XLR to 3.5mm audio output cable
- Type-C charging cable

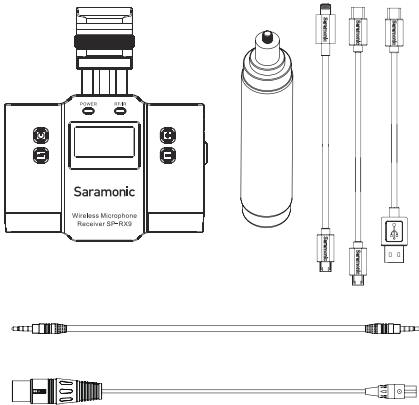

SP-RX9

- Wireless receiver and mixer: SP-RX9
- Hand grip
- USB Type-A to Type-C charge cable
- Micro USB to USB Type-C cable
- Micro USB to Lightning cable
- 3.5mm TRRS to TRRS audio output cable
- Mini XLR to standard XLR cable

Warranty card

User manual

声明

请在使用前仔细阅读本手册，并严格按照说明进行操作和存储。请保存以供将来参考。

如果用户手册不能帮助您解决某些问题，请向零售商寻求帮助或给我们发送电子邮件：info@saramonic.com。

注意事项

1. 请勿在水下使用本机，也不要使其受到雨淋。请存放在阴凉干燥处。
2. 请在常温下使用和存放。请经常将其从过热状态移至过冷状态，并远离加热器和烤箱等热源。
3. 使用和存放时，请注意防尘和防潮。
4. 注意剧烈碰撞。
5. 为避免声音反馈，请勿将麦克风靠近扬声器。
6. 为获得最佳拾音模式，请勿将手放在麦克风头上。
7. 长时间不使用设备时，请从电池盒中取出电池。

目录

概述	46
便携式接收机 UwMic9-RX9	46
介绍	46
产品结构.....	46
配件安装.....	47
LCD 显示屏操作指南	48
腰包式发射机 UwMic9 TX9	52
简介.....	52
产品结构.....	52
安装配件.....	53
LCD 显示屏操作指南	54
手持式麦克风 UwMic9 HU9	57
简介.....	57
产品结构.....	57
设置向导.....	58
手雷式发射机 UwMic9 TX-XLR9	59
简介.....	59
产品结构.....	59
安装配件.....	60
LCD 显示屏操作指南	61
卡农接收机 RX-XLR9	64
简介.....	64
产品结构.....	64
附件.....	65
屏幕操作指南.....	66
UwMic9 SP-RX9	69
简介.....	69
产品结构.....	69
屏幕操作指南.....	71
操作指南	76
规格书	80
接收机 RX9 和 RX-XLR9	80
发射机 TX9, HU9 和 TX-XLR9.....	81
接收机 SR-RX9	82
包装清单	83

概述

Saramonic UwMic9 UHF 无线麦克风套装适用于便携式无线操作，可在多种环境中使用例如数码单反相机的视频录制，实地录音，广播电视，电子新闻采集，现场采访等。

便携式接收机 UwMic9-RX9

介绍

枫笛 UwMic9-RX9 便携式接收机可提供数字音频处理级音质和稳定的模拟 FM 调制。它可提供宽频率范围并覆盖多个通道，易于使用的高清显示屏和小尺寸接收机可完美连接在 DSLR 摄像机上。UwMic9-RX9 具有自动扫描功能，可以自动搜索可用传输频率通道设置，同时也可选择输出信号是单声道 / 立体声。

产品结构

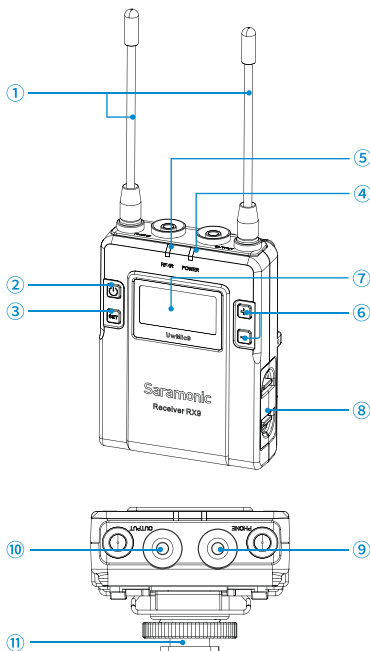

- ① 天线
- ② 电源开关
长按打开 / 关闭 UwMic9-RX9。

- ③ 设置按键
长按 SET 键进入菜单选项, 再短按 SET 键确认选项。
若再次长按 SET 键, 则会退出设置且不保存。
- ④ 电源指示灯
电池电量指示如下:
绿灯: 电量充足。
红灯: 电量低。
- ⑤ 射频指示和 IR (红外发射端口)
将设置频率发射到发射机上。
RF 射频输入电平指示器显示如下:
绿灯: 射频信号强
红灯: 射频信号弱或已经断开连接 RF
- ⑥ +/- 按键
选择显示屏上的功能或者数值
- ⑦ LCD 显示屏
显示菜单, 详细请参考“显示屏操作指南”
- ⑧ 电池仓
放置两节 AA 电池 (不含)
- ⑨ 耳机接口
这是一个 3.5mm 直径的立体声耳机接口。插入耳机可监听音频输出。
- 注意: 请不要使用单声道接头的耳机监听, 否则会造成耳机短路及声音输入失真。**
- ⑩ 输出接口
用适配的输出线将 RX9 连接到单反相机, 摄像机, 混音器或录音笔等录音设备。
- ⑪ 标准冷靴

配件安装

1. 将适配连接线插入输出接口

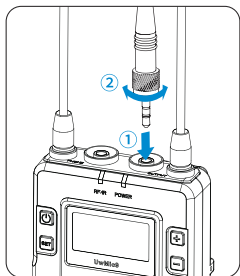

- ① 将适配线插入输出接口
② 为了安全连接, 请旋转锁住连接器

2. 附带金属背夹。请参考“安装配件”

3. 连接冷靴

- ① 安装冷靴适配器前请如图先装上金属背夹。
- ② 拉开金属背夹, 让金属背夹和接收机之间保留空隙。
- ③ 将金属背夹和冷靴适配器上的两个立槽对齐, 并按照箭头的方向推入适配器。
- ④ 推入冷靴适配器直到金属背夹完全嵌入适配器上的凹槽内。

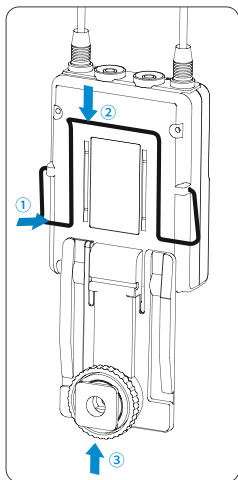

LCD 显示屏操作指南

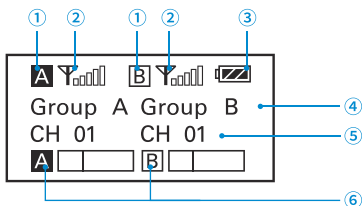

主屏幕, 如果 20 秒内不执行操作, 显示将会自动回到主屏幕。

① 组图标

- A** 表明 A 组通道功能关闭
- A** 表明 A 组通道功能打开。

② 射频电平指示器

表明当前的接收电平。

③ 电池电量指示灯

显示电池电量, 指示灯闪烁时请尽快更换电池。

④ 通道组名称

⑤ 当前频道

显示当前频道数。图中显示为 A 组通道, 01 频道。

⑥ 音频输入电平表

显示音频输入电平。

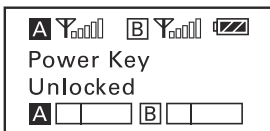

电源键锁, 长按 SET 键 锁定 / 解锁 电源键。锁定电源键以防接收机在使用期间被无意关闭。

解锁状态: 长按电源键打开 / 关闭接收机(系统默认)

锁定状态: 按下电源键后接收机不会被关闭

注意: 如果在锁定状态下拆出电池并重新插入, 接收机依旧处于锁定状态。

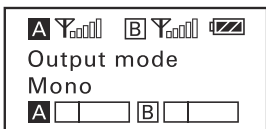

输出模式, 输出模式可以选择单声道或立体声。当输出模式是单声道时, 左声道和右声道的音频将被混合。当输出模式是立体声, 左(A组)和右(B组)音频声道输出将是独立的。系统默认单声道。

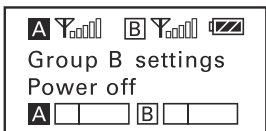
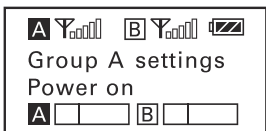

通道开启, 仅使用一组通道时, 请关闭其他组通道以节省电量。

系统默认 A 组通道打开, B 组通道关闭。

若同时使用两个发射机, 请将其中一个接收机设置为不同的通道组以避免干扰和噪音。

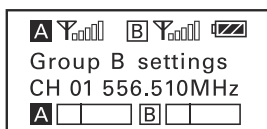
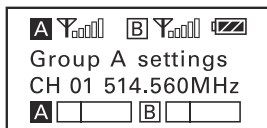

选择频道, 操作细节请参考“手动设置接收机频道”

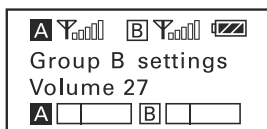
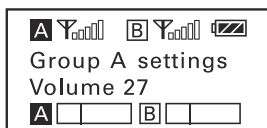

设置输出音量, 输入音量设置范围 0-30, 电源关闭后设置音量保存, 系统默认 27。

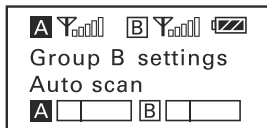
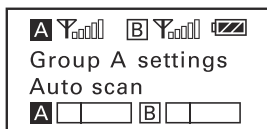

自动扫描功能, 自动扫描可用且清晰的通道。细节操作请参考“使用自动扫描功能”

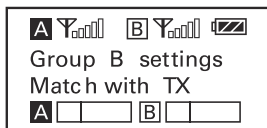
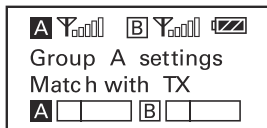

红外匹配功,通过红外匹配接收机和发射机,操作细节请参阅“匹配通道接收机和发射机”

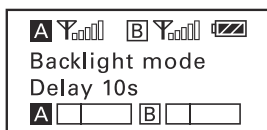

设置背光灯,设置背景灯光 常开或延迟 60/30/10 秒或常关。系统默认延迟 10 秒

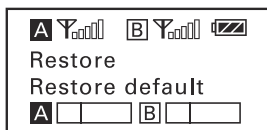

恢复出厂设置,确认后 RX9 的参数恢复到出厂默认设置

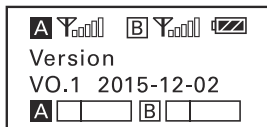

UwMic-RX9 的版本号

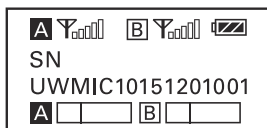

出厂序列号

腰包式发射机 UwMic9 TX9

简介

UwMic9-TX9 腰包式发射机是完整 UwMic9 音频系统的一部分，它可提供数字音频处理级音质。使用的功能包括：LCD 显示屏、自动通道设置功能。UwMic9-TX9 结构紧密，它采用晶体控制锁相环合成器，同时配备有静音功能和一个 3.5mm 锁式插头型话筒输入连接器。RF 功率输出可在高、中、低之间来切换。

产品结构

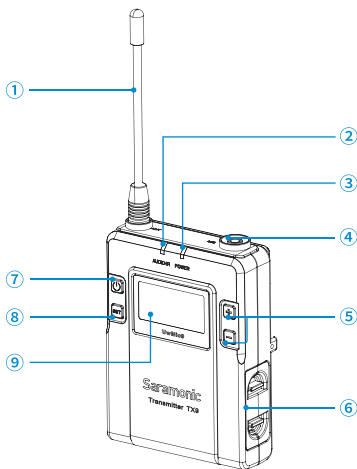

- ① 天线
- ② 音频指示器 (IR 红外探测端口)
音频指示器：表示音频输入电平
IR (红外探测端口)：从接收机获取相应频率
绿灯长亮：合适的音频输入电平。
红灯闪烁：静音 (即禁用)。
设置静音功能，操作细节参考“Set Mute key (设置静音键)”。
- ③ 电源指示灯：
绿色常亮：电池电量充足。
红色常亮：电池电量低。
- ④ 音频输入接口 (3.5mm 锁式插头类型)
用以连接适配的领夹式话筒。
- ⑤ +/- 按键
上下翻页，调节参数。
- ⑥ 电池仓
放入两节 AA 电池 (碱性，镍氢或锂电池)。

⑦ 电源 / 静音键

功能	操作
打开电源	长按电源键一秒或以上
关闭电源	长按电源键直到关机
打开静音	短按电源键
关闭静音	

⑧ SET 键

长按 SET 键进入菜单功能设置。短按 SET 键确认功能设置或者再次长按退出功能设置且设置不保存。

⑨ LCD 显示

显示菜单, 操作细节请参考 "LCD 屏幕操作指南 "

安装配件

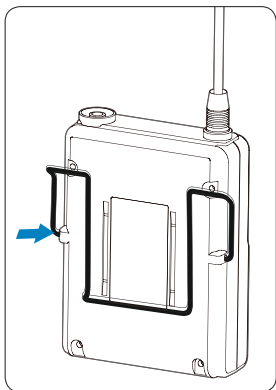

1. 连接金属背夹

将金属背夹一端插入发射机侧面的小孔, 另一端插入另一侧的小孔。

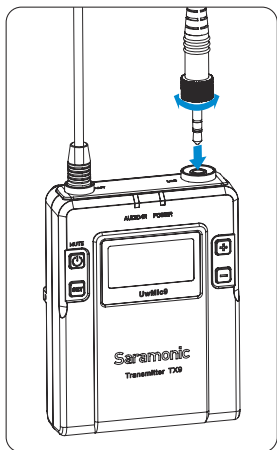

2. 连接麦克风



安全连接后锁定连接器

注意：安装或拆卸麦克风之前请关闭发射机。

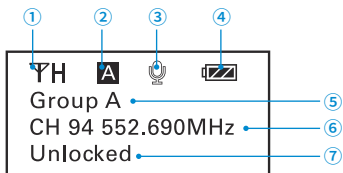
LCD 显示屏操作指南



主屏幕。在其他屏幕下 20 秒内无操作会自动回到主屏幕。

- ① 射频传输功率指示器
显示当前传输功率电平。相关设置细节请参阅“选择射频”
- ② 通道组指示。表示通道组。
- ③ 静音指示
 关闭静音  打开静音
- ④ 电池电量指示
显示电池电量。当电池图标开始闪烁时请尽快更换电池。
- ⑤ 通道组名称
- ⑥ 通道和频率。显示当前通道和频率。
- ⑦ 表示电源 / 静音键状态

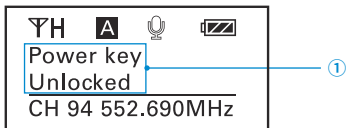

部分菜单显示, 可显示不同的菜单选项。通过 +/- 键切换功能。

设置电源锁, 选择解锁或锁定。

设置“Locked (锁定)” 锁定电源键以防发射机在使用期间被无意关闭或静音。

系统默认“解锁。”



选择通道, 在频率范围 514MHz-596MHz 内有 96 个通道。系统默认“通道 01”和“514.560MHz”



选择通道组, 可以选择“A”或“B”通道组。每个通道组有 96 个通道。系统默认“A 组”



选择射频功率电平, 可以设置发射 RF 功率为高, 中或低。系统默认“高”



设置静音键, 如需音频静音, 请选择“Enable (启用)”, 然后短按电源键开启静音。系统默认“Enable (启用)”



红外匹配，选择匹配接收机。正在匹配时屏幕会显示“Matching（匹配中）”。匹配成功后会显示“Sync Finished（匹配完成）”



设置背景灯，选择 开 / 关或延迟 10/30/60 秒。系统默认“Delay 10s（延迟 10 秒）”



恢复出厂设置。

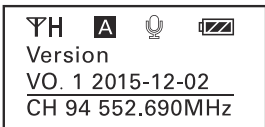

UwMic9-TX9 版本。



出厂序列号。

手持式麦克风 UwMic9 HU9

简介

枫笛 Saramonic HU9 是一款手持式无线话筒 UHF 发射机。设有一个小巧的金属机身，易于阅读的液晶显示屏，射频电源开关和晶体控制锁相环合成器。广播级的麦克风将捕捉清澈和丰富的声音。它有一个内置天线，有噪音抑制功能和电源锁定功能。HU9 的通道经由红外线接收机同步。

产品结构

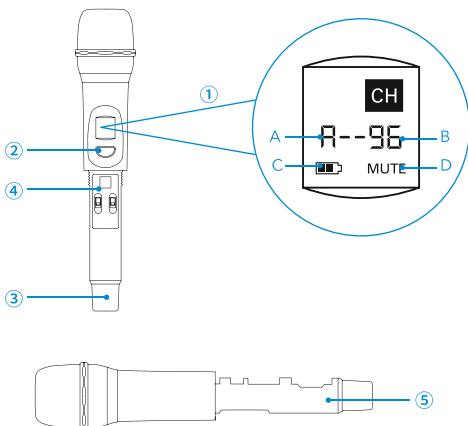

① LCD 屏幕

A. 通道组

两个通道组：A 组和 B 组。每个通道组有 96 个通道。

B. 通道数

C. 电池电量显示

D. 静音。音频静音。

LCD 屏显示：A 组 96 通道。

② 电源 / 静音键

电源键：长按打开 / 关闭 HU9。

静音键：在音频输出时短按变为静音。再次按下恢复音频输出。

注意：静音时，音频信号无输出，射频信号正常传输。

③ 天线

④ 面板操作

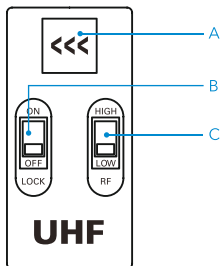

- A. 红外探测器。接收接收机频率。
- B. 锁定键。选择 ON 锁定电源键。以防发射机在使用期间被无意关闭

注意：锁定开关不会锁定静音功能。

- C. 射频功率。设置发射机的输出电平高或低。

⑤ 电池仓

放入两节 AA 电池 (不含)。可以使用碱性, 镍氢或者锂电池。

设置向导

1. 安装电池。详情参考“UwMic9-HU9”
2. 设置锁定键打开或关闭。
3. 设置射频功率高或低。发射功率电平变化取决于该设置。
4. 按下电源键打开 HU9。
5. 打开接收机 UwMic9-RX9 与发射机 HU9 同步。操作细节请参考“HU9”
6. 同步成功后, HU9 屏幕会显示和接收机一致的通道组和通道数。根据箭头方向关闭手柄。

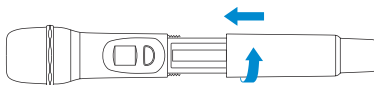

8. 开始使用。

手雷式发射机 UwMic9 TX-XLR9

简介

枫笛 UwMic9-TX-XLR9 便携插接式发射机是完整 UwMic9 音频系统的一部分，它可提供宽频率范围并覆盖多个通道，易于使用的功能包括：大显示屏，+48V 幻象电源供电及静音。UwMic9-TX-XLR9 可以连接 XLR 麦克风或者混音器或者其他设备的线路输出。它适用于便携式无线操作，适用范围广泛，例如单反相机的视频录制，广播电视，电子新闻采集等。

产品结构

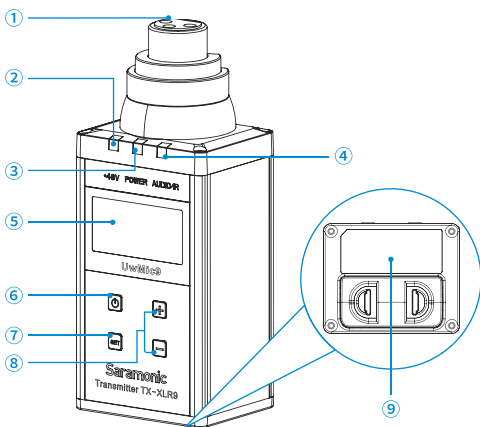

- ① XLR 音频输入接口
连接 XLR 麦克风或其他音频设备的线路输出。
- ② +48V 电源指示器
+48V 幻象电源开启时指示灯亮
- ③ 电源指示器
电池电量指示如下：
绿灯长亮：电池电量充足
红灯常亮：电池电量低
- ④ 音频指示 /IR (红外探测端口)
音频指示：表示音频输入电平
IR (红外探测端口)：从接收机获得载波频率。
绿灯长亮：音频输入水平正常
红灯闪烁：无声音 (即，未连接)。有关静音功能设置的
细节操作，请参考“设置静音键”。
- ⑤ LCD 屏幕
显示菜单，详情请参考“LCD 屏幕操作指南”
- ⑥ 电源 / 静音键

打开电源开关或者静音功能开关。

功能	操作
打开电源	长按电源键一秒或以上
关闭电源	长按电源键直到关机
打开静音	短按电源键
关闭静音	

⑦ SET 键

调整显示的功能设置, 进入功能菜单。
长按 SET 键进入菜单功能设置。短按 SET 键确认功能设置或者再次长按退出功能设置且设置不保存。

⑧ +/- 键

选择功能或调节显示的数值, 如音量。

⑨ 电池仓

放入两节 AA 电池(可以使用碱性, 镍氢或者锂电池)。
安装电池的方向细节请参考“安装电池”

安装配件

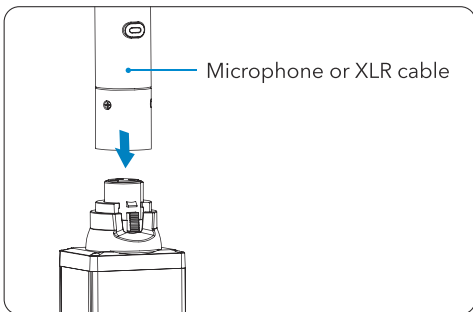

1. 连接麦克风或 XLR 线

将麦克风或 XLR 线接入 UwMic9 TX-XLR9 音频输入口。

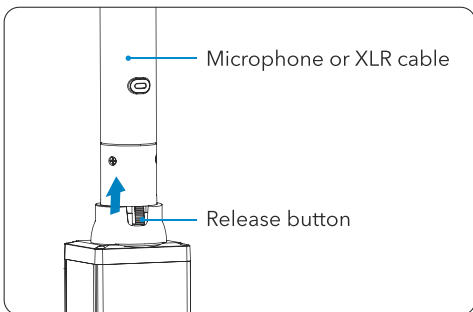

2. 断开麦克风或 XLR 线



按下释放键并拔出麦克风或 XLR 线

注意：在连接或移除麦克风前请关闭发射机。

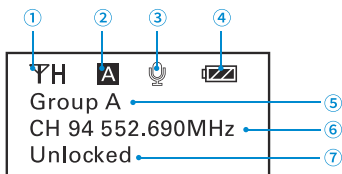
LCD 显示屏操作指南



主屏幕。在其他屏幕下 20 秒内无操作会自动回到主屏幕。

- ① 射频传输功率指示器
显示当前传输功率电平。相关设置细节请参阅“选择射频”
- ② 通道组指示。
表示通道组。
- ③ 静音指示
 Mute OFF  Mute ON
- ④ 电池电量指示
显示电池电量。当电池图标开始闪烁时请尽快更换电池。
- ⑤ 通道组名称
- ⑥ 通道和频率。显示当前通道和频率。
- ⑦ 表示电源 / 静音键状态

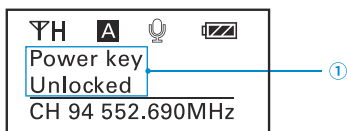

部分菜单显示。可显示不同的菜单选项。通过 +/- 键切换功能。

设置电源锁，选择解锁或锁定。

设置“Locked (锁定)”锁定电源键以防发射机在使用期间被无意关闭或静音。

系统默认“解锁。”



选择通道，长按 SET 键键入菜单。使用“+/-”选择你需要的频道，短按 SET 键确认。



选择通道组，可以选择“A”或“B”通道组。每个通道组有96个通道。系统默认“A组”



设置麦克风驱动电源(+48V)，使用需要外部电源供电的麦克风时，可以从发射机供电。当设置为 ON 时，电源供电给所连接的麦克风，+48V 指示灯亮起。系统默认“+48V OFF”。

注意：当 TX-XLR9 连接无需供电的麦克风、混音器、或其他非平衡输出的设备时，请不要打开 48V 幻象电源供电模式，否则有可能对发射机和音频设备造成损害。



选择射频功率电平，可以设置发射 RF 功率为高，中或低。系统默认“高”。



设置静音键，如需音频静音，请选择“Enable(启用)”，然后短按电源键开启静音。系统默认“Enable(启用)”。



红外匹配，选择匹配接收机，正在匹配时屏幕会显示“Matching (匹配中)”。匹配成功后会显示“Sync finished (匹配完成)”。



设置背景灯，选择开/关或延迟10/30/60秒。系统默认“Delay 10s (延迟10秒)”。



恢复出厂设置。



UwMic9-TX-XLR9 版本。



出厂序列号。

卡农接收机 RX-XLR9

简介

Saramonic UwMic9 RX-XLR9 是一款紧凑型 XLR 插入式无线接收器。它可以直接插入摄像机或录像机的 XLR 麦克风输入，而不会妨碍其他配件。XLR 连接器可以顺时针或逆时针旋转。

接收器可通过两节 AA 电池供电或通过 USB Type-C 接口供电。它可提供宽频率范围并覆盖多个通道，易于使用的高清屏幕，3.5mm 耳机监听孔，同时具有自动扫描功能，发射器和接收器之间支持红外同步。

产品结构

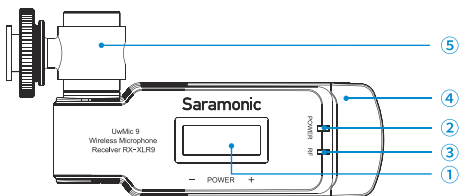

- ① 显示屏
显示菜单信息，详情请参阅“显示屏操作指南”
- ② 电源指示灯
显示电池电量
绿灯：电池电量充足。
红灯：电池电量低。
- ③ 射频指示和 IR (红外发射端口)
红外发射端口将设定频率发送到发射机。
RF 射频输入电平指示如下：
绿灯：射频信号强
红灯：射频信号弱或已经断开连接
- ④ 天线
- ⑤ 可旋转 XLR-3-11C 型 (公) 连接器
将接收器连接到摄像机或调音台的 XLR 麦克风输入。
接收器可以旋转最大角度 320°。

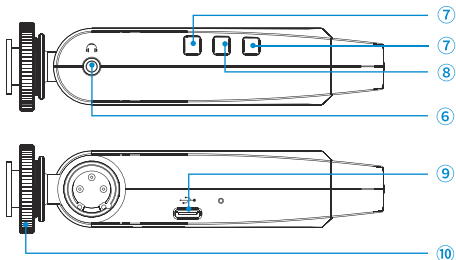

⑥ 耳机接口

这是一个 3.5mm 直径的立体声耳机接口。插入耳机可监听音频输出。

注意: 请不要将耳机连接到单声道接口, 否则会造成耳机短路及声音输入失真。

⑦ +/- 按键

选择显示屏上的功能或者数值。长按“-”进入菜单

⑧ 电源键

长按开 / 关机, 短按确认选项。

⑨ USB Type-C 接口

接收机接入移动电源时, 无论是否装入 AA 电池, 都由移动电源供电。

如在接收机关闭时接入移动电源, 接收机会自动开机。

注意: 如未连接移动电源, 接收机自动由 AA 电池供电, 如未接入电池, 接收机会自动关闭。

⑩ 标准冷靴座

附件

如需将接收机连接至相机, 请按照以下步骤操作:

1. 如图所示, 将冷靴座固定在相机热靴, 然后使用锁定螺丝固定好冷靴座。

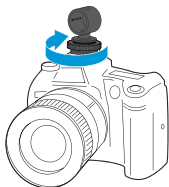

2. 将接收器的可旋转 XLR 接头插入冷靴适配器。

3. 使用随附的 XLR 转 3.5mm 音频线将接收器连接至相机的麦克风插孔

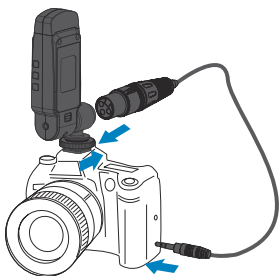

屏幕操作指南

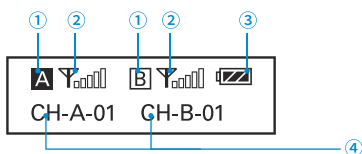

主屏幕，如果 20 秒内不执行操作，将会自动跳转到主屏幕。

① 组图标

 表明 A 组通道功能关闭

 表明 A 组通道功能打开。

② 射频电平指示器

表明当前的接收电平。

③ 电池电量指示灯

显示电池电量，指示灯闪烁时请尽快更换电池。

④ 通道组和频道

显示当前 A 组和 B 组的频道。“CH-A-01”表示 A 组 01 频道。



设置电源锁，长按“-”进入菜单选项，短按“+/-”选择锁定或解锁电源键，然后短按电源键确认。设置“Locked（锁定）”锁定电源键以防接收机在使用期间被无意关闭。

解锁状态：长按电源键打开 / 关闭接收机（系统默认）

锁定状态：按下电源键后接收机不会被关闭

注意：如果在锁定状态下拆出电池并重新插入，接收机依旧处于锁定状态。

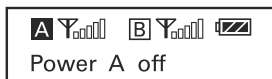
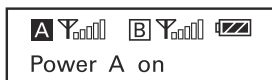

通道组状态，仅使用一组通道时，请关闭其他组通道以节省电量。

系统默认 A 组通道打开，B 组通道关闭。

若同时使用两个发射机，请将其中一个发射机设置为不同的通道组以避免干扰和噪音。





CHA 01 514.56MHz





CHB 01 556.51MHz

选择频道, 长按“-”进入菜单选项。使用“+/-”选择所需的通道, 然后短按 POWER 键确认。默认为 A 组 01 通道(514.56MHz)和 B 组 01 通道(556.51MHz)。





Volume A 27





Volume B 27

设置输出音量, 输入音量设置范围 0-30, 电源关闭后设置音量保存。系统默认 27。





Auto scan A





Auto scan B

自动扫描功能, 自动扫描可用且清晰的通道, 具体操作请参考“使用自动扫描功能”。





Match A with TX





Match B with TX

红外匹配功能, 通过红外匹配接收机和发射机, 操作细节请参阅“匹配通道接收机和发射机”。



Light delay 10s

设置背光灯, 设置背景灯光常开或延迟 60/30/10 秒或关闭。系统默认延迟 10 秒。



Restore default

恢复出厂设置。



V1.0 Rel. 826001A

UwMic9 RX-XLR9 版本号。



XLRRX09000000000

出厂序列号(SN 码)。

UwMic9 SP-RX9

简介

SP-RX9 是一款紧凑型双通道无线接收器和混音器，非常适合 iOS/Android 移动设备或相机进行视频拍摄录制。它可以与 UwMic9 系统中的发射器配对并接收录入音频。同时，它是一个独立的混音器，支持三种输入方式。

SP-RX9 内置锂电池，可以通过 USB Type-C 接口进行直流电源供电。它配有一个铝制手柄，可以在移动中进行记录，也可以安装在三脚架上固定使用。接收器顶部的标准冷靴座适用于连接其他附件。

产品结构

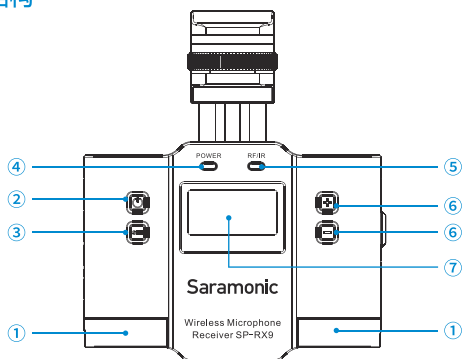

- ① 天线
- ② 电源开关
长按打开 / 关闭 SP-RX9。
- ③ 设置按键
长按 SET 键进入菜单选项，再短按 SET 键确认选项。
若在进入菜单选项后长按 SET 键，则会退出设置且不保存。
- ④ 电源指示灯
电池电量指示如下：
绿灯：电量充足。
红灯：电量低。
- ⑤ 射频指示和 IR (红外发射端口)
将设置频率发射到发射机上。
RF 射频输入电平指示器显示如下：
绿灯：射频信号强
红灯：射频信号弱或已经断开连接 RF
- ⑥ +/- 按键
选择显示屏上的功能或者数值
- ⑦ LCD 显示屏
显示菜单，详细请参考“显示屏操作指南”

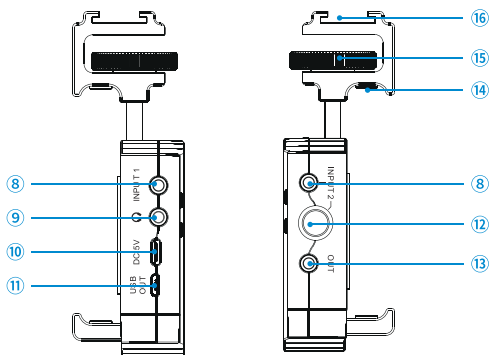

⑧ 3.5mm 麦克风输入接口

⑨ 耳机接口

这是一个 3.5mm 直径的立体声耳机接口。插入耳机可监听音频输出。

注意：请不要使用单声道接头的耳机监听，否则会造成耳机短路及声音输入失真。

⑩ USB TYPE-C 接口

⑪ Micro USB 输出接口

接收机可通过 Micro USB 转 Lightning 音频线连接至 iOS 设备，或者通过 Micro USB 转 TYPE-C 音频线连接至安卓手机。

⑫ 迷你卡农麦克风输入接口

⑬ 3.5mm 输出接口

接收机可通过 3.5mm TRRS 转 3.5mm TRRS 音频线连接至安卓手机 / 苹果手机 (含 3.5mm 接口) 或相机。

⑭ 手机固定支架

可调节至适合高度固定手机

⑮ 调节旋钮

⑯ 标准冷靴座

⑰ 手柄



屏幕操作指南

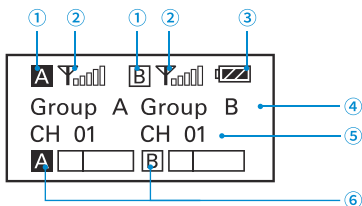

主屏幕。如果 20 秒内不执行操作，将会自动回到主屏幕。

① 组图标

A 表明 A 组通道功能关闭

A 表明 A 组通道功能打开

② 射频电平指示器

表明当前的接收电平。

③ 电池电量指示灯

显示电池电量，指示灯闪烁时请尽快更换电池。

④ 通道组名称

⑤ 当前频道

显示当前频道数。图中显示为 A 组通道, 01 频道。B 组通道, 01 频道。

⑥ 音频输入电平表

显示音频输入电平。

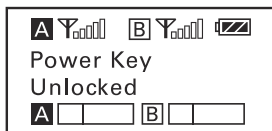

电源键，长按 SET 键 锁定 / 解锁 电源键。锁定电源键以防接收机在使用期间被无意关闭。

解锁状态：长按电源键打开 / 关闭接收机（系统默认）

锁定状态：按下电源键后接收机不会被关闭

注意：如果在锁定状态下拆出电池并重新插入开机，接收机依旧处于锁定状态。

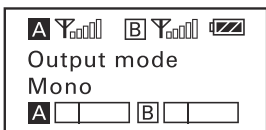

输出模式, 输出模式可以选择单声道或立体声。

当输出模式是单声道 (Mono) 时, 左声道和右声道的音频将被混合。

当输出模式是立体声 (Stereo) 时, A 组的无线麦克风音频和 INPUT1 的音频在左声道。

系统默认单声道 (Mono)。

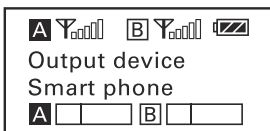

输出设备, 输出设备可以选择智能手机 (Smart phone) 或相机 (Camera)。系统默认为智能手机。

将 SP-RX9 连接到相机或摄像机时, 请记得将其更改为“Camera (相机)”。

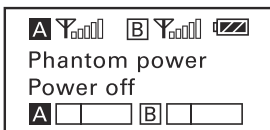

48V 幻象电源, 如果外接卡农麦克风需要电源, 请长按 SET 按钮打开 48V 幻像电源。系统默认为不供电。

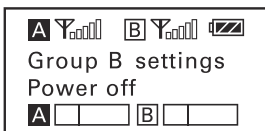
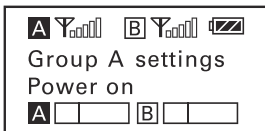

通道开启, 仅使用一组通道时, 请关闭其他组通道以节省电量。系统默认 A 组通道打开, B 组通道关闭。若同时使用两个发射机, 请将其中一个接收机设置为不同的通道组以避免干扰和噪音。

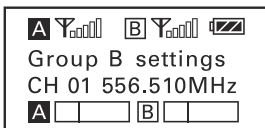
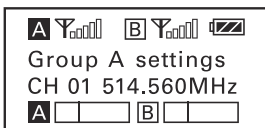

选择频道, 操作细节请参考“手动设置接收机频道”

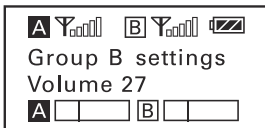
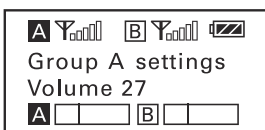

设置输出音量, 输入音量设置范围 0-30。电源关闭后音量设置依然保存。系统默认 27。

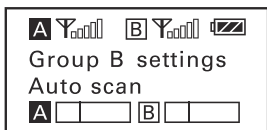
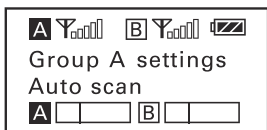

自动扫描功能, 自动扫描可用且清晰的通道。细节操作请参考“使用自动扫描功能”

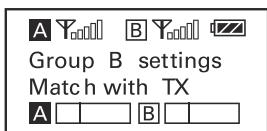
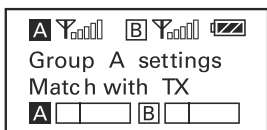

红外匹配功能, 通过红外匹配接收机和发射机。操作细节请参阅“匹配通道接收机和发射机”

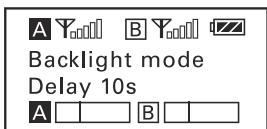

设置背光灯, 设置背景灯光常开或延迟 60/30/10 秒或常关。系统默认延迟 10 秒

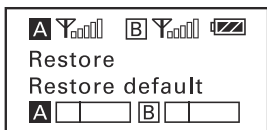

恢复出厂设置。

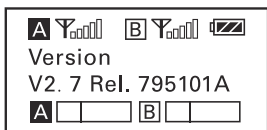

SP-RX9 的版本号。

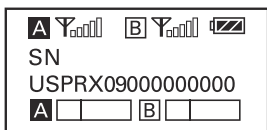

出厂序列号。

操作指南

1. 安装电池

① UwMic9-RX9 和 UwMic9-TX9:

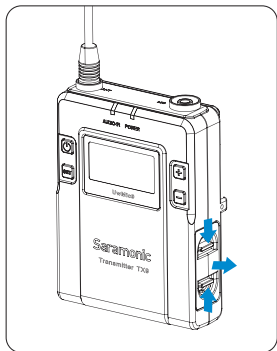

- 长按电源键关机。
- 向内按压两个锁扣, 拉出电池仓。
- 根据极性标记装入两节 AA 电池并关闭仓。
请确保电池仓已安全锁定。

② UwMic9-HU9

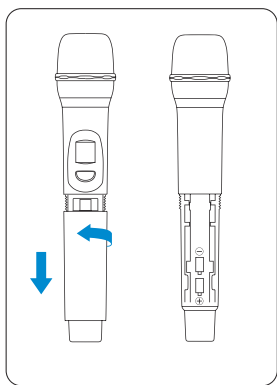

- 长按电源键关机
- 按箭头方向旋转并向下拉动手持部分, 直至电池仓可见。
- 装入两节 AA 电池。按照正负极标注正确安装电池。

③ UwMic9 RX-XLR9

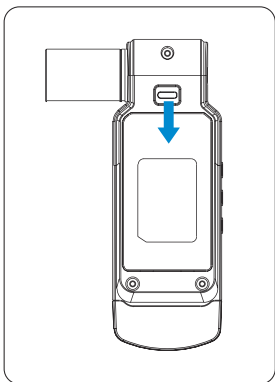

- 长按电源键关机
- 如图所示，向下拨动锁扣取下电池盖
- 根据极性标记装入两节 AA 电池并关闭电池盖

注意：

- ① 长时间不使用该设备时，请从电池仓中取出电池。
- ② 始终使用相同型号的电池。
- ③ 操作过程中更换电池可能会产生噪音。请确保该装置更换电池之前已关闭。

2. 使用适配音频线连接接收机到相机麦克风口 / 摄像机 / 混音器。

3. 长按电源键打开接收机。

4. 接收机通道设置方法：

- ① 使用自动扫描功能

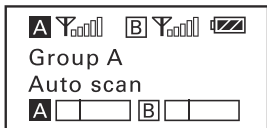

使用 +/- 键在接收机屏幕上选择“Auto scan (自动扫描)”

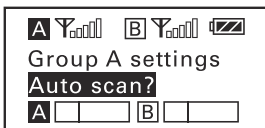

长按 SET 键进入“Auto scan ? (自动扫描?)”

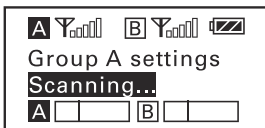

短按 SET 键确认。

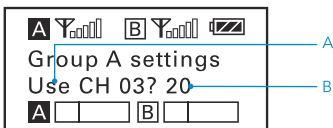

屏幕会自动显示最少噪音和干扰的通道

A. 表明当前最小噪声通道是 03, 并询问是否使用该通道。可以短按 SET 键确认使用该通道 (20 秒) 或长按 SET 键退出显示菜单且不保存设置。

B. 倒计时 20 秒。

注意:

- ① 20 秒后回到主屏幕, 设置不保存。
- ② 接通电源时可能会产生噪音, 可以调小相应接收机的音频输入电平。

② 手动设置接收机通道

- 使用 +/- 键在接收机屏幕上选择通

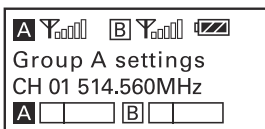

- 长按 SET 键进入菜单选择

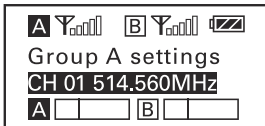

- 使用 +/- 键选择所需的通道, 并通过短按 SET 键确认。

5. 接收机和发射机的通道匹配

- ① 利用红外线传输技术, 将接收机上设定的频率, 传输到发射机

使用红外匹配 TX9 和 TX-XLR9

- 长按电源键打开发射机
- 在接收机上使用 +/- 键选择 “Match with TX”

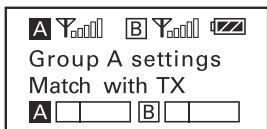

在发射机上使用 +/- 键选择 “Match with RX”



- 同时长按接收机和发射机的 SET 键选择菜单短按“SET 键”确认。
- 将接收机的红外发射端口对着发射机上的红外探测端口 (即 IR 指示灯处), 请保持两者之间的距离小于 20 厘米。
- 如果屏幕显示 “Sync Finished (匹配完成)”, 发射机使用频率设置完成。
- 匹配成功后, 按下接收机 SET 键回到之前的菜单。

使用红外匹配 HU9

- 打开发射机。
- 在接收机上使用 +/- 键选择 “Match with TX”。

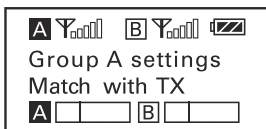

- 将接收机和发射机的红外检测器 (即电池仓上方设置区域顶端的红色方形区域) 相互靠近。
- 如果同步成功, HU9 的通道组和通道将与接收机一致。
- 匹配成功后, 按下接收机 SET 键回到之前的菜单。

注意: 当使用红外连接时, 请把接收机和发射机保持在 20cm 范围内。20 秒后, 红外传输完成, 返回上一级菜单。

② 手动设置发射通道

UwMic9 TX9 和 UwMic9 TX-XLR9

- 长按电源键打开发射机。

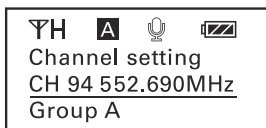

- 在发射机上使用 +/- 键选择 “channel Setting” 菜单。
- 长按 SET 键选择菜单。
- 使用 +/- 键选择与接收机相同的频道然后短按 SET 键确认匹配。

UwMic9 HU9

- 长按电源键开机。
- 双击进入设置, 此时 A 或 B 闪烁, 单击可以改变通道, 再次双击, 保存更改并跳转到频段设置, 此时频段闪烁, 单击可以增加频段, 再次双击保存更改并退出。

6. 安装配置接收机和发射机所需要的配件。详情参考“安装配件”。
7. 可以准备录音了。

规格书

接收机 RX9 和 RX-XLR9

频道数	96
频道组	A 和 B
类型	晶体控制锁相环合成器
音频输出连接器	RX9: 3.5 mm 立体声 RX-XLR9: XLR-3-11C 公头
天线	1/4 λ 导线天线
音频输出电平	-60 dBV
耳机输入电平	30mW (16 Ω)
载波频率	514 MHz - 596 MHz
接收灵敏度	-95 dBm
信噪比	70 dB 及以上
语音延迟	12 ms
参考偏差	±5 kHz (-60 dBV, 1 kHz input)
频率响应	40 Hz to 18 kHz (+/-3dB)
失真	低于 0.5%

分散抑制	-60 dB
音频输入电平	-60 dBV (MIC 输入, 0dB 衰减)
重量	RX9: 约 218.7g (不含电池)
	RX-XLR9: 约 96 克
电池	两节 AA 电池
尺寸	RX9: 170.9 × 63.5 × 30.0 mm
	RX-XLR9: 112×63×26mm
工作温度	工作温度
储存温度	-20°C 到 +55°C

发射机 TX9, HU9 和 TX-XLR9

频道数	96
频道组	A 或 B
类型	晶体控制锁相环合成器
载波频率	514 MHz - 596 MHz
参考偏差	±5 kHz (-60 dBV, 1 kHz input)
信噪比	70 dB 及以上
分散抑制	-60 dB
声音延迟	12 ms
天线	1/4 λ 导线天线
音频输入连接器	TX9: 3.5mm 立体声
	HU9: 无
	TX-XLR9: XLR-3-11C 类型 (母头)
参考音频输入电平	-60 dBV (MIC 输入, 0 dB 衰减)
失真	0.5% 或更少
重量	TX9: 约 211.4g (不含电池)
	HU9: 约 338.2g (不含电池)
	TX-XLR9: 约 138g (不含电池)
电池	两节 AA 电池
尺寸	TX9: 170.9 × 63.5 × 30.0 mm
	HU9: 254.0 × 52.0 × 52.0 mm
	TX-XLR9: 105.5×43×34.7 mm
工作温度	0°C 到 50°C
储存温度	-20°C 到 +55°C

接收机 SR-RX9

频道数	96
频道组	A 和 B
类型	晶体控制锁相环合成器
音频输入	两个 3.5mm 接口和一个迷你卡农接口
音频输出	一个 3.5mm 接口和一个 Micro USB 接口
耳机输出	3.5mm 接口
INPUT 1 增益	20dB
INPUT 2 和迷你卡农端增益	20dB
Micro USB 端增益	20dB
INPUT 1 和 INPUT 2 电源	5V 电源供电
迷你卡农口幻象电源	48V 电源供电
天线	内置 1/4 λ 导线天线
音频输出电平	-60 dBV
耳机输出电平	30mW (16 Ω)
载波频率	514 MHz - 596 MHz
接收灵敏度	-95 dBm
信噪比	70 dB 及以上
声音延迟	12 ms
参考偏差	± 5 kHz (-60 dBV, 1 kHz input)
频率响应	40 Hz to 18 kHz (+/-3dB)
失真	低于 0.5%
分散抑制	-60 dB
电池	内置锂电池 (1200mA)
电源	DC 5V (USB Type-C)
尺寸	100.0 \times 38.6 \times 259.6mm (含手柄)
支架调节范围	66.4mm-84.1mm
重量	约 433g (含手柄)
工作温度	0 $^{\circ}$ C 到 50 $^{\circ}$ C
储存温度	-20 $^{\circ}$ C 到 +55 $^{\circ}$ C

包装清单

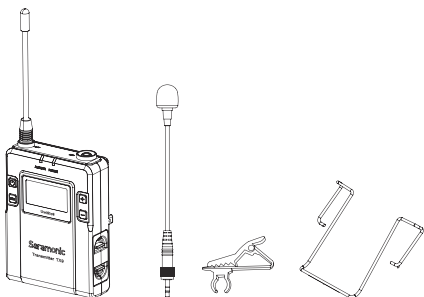

TX9

- 腰包式发射机 TX9
- 全指向型领夹麦克风
- 麦克风固定夹
- 防风棉套
- 金属背夹

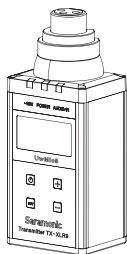

TX-XLR9

- 手雷式发射机 TX-XLR9

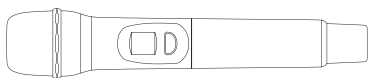

HU9

- 手持式发射机 HU9

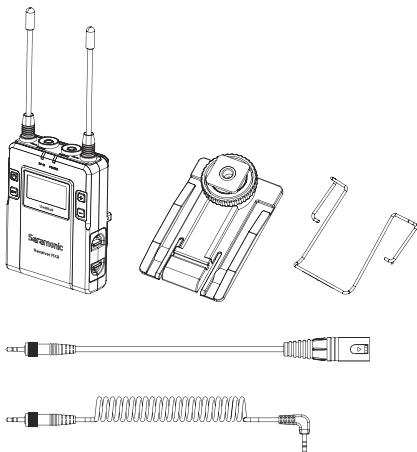

RX9

- 便携式接收机 RX9
- 冷靴适配器
- 金属背夹
- XLR 转 3.5mm 带锁音频线
- 3.5mm 带锁弹簧音频线

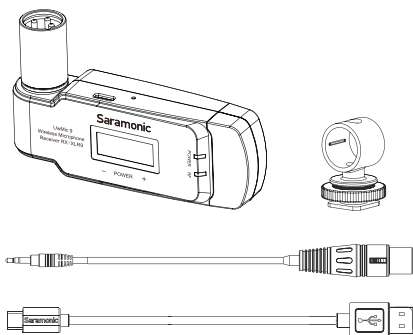

RX-XLR9

- 卡农接收机: RX-XLR9
- 冷靴适配器
- XLR 转 3.5mm 带锁音频线
- Type-C 充电线

EU Declaration of Conformity

- RoHS Directive (2011/65/EU)

Hereby, Shenzhen Jiayz Photo Industrial.,Ltd declares that the radio equipment model UwMic9 system is in compliance with Directive 2014/53/EU.

The full text of the EU declaration of conformity could be downloaded via below link:

www.saramonic.com/product/13271/



Please follow our WeChat account for more details.

扫描二维码关注枫笛Saramonic微信公众号。

www.saramonic.com

Saramonic is a trademark registered and owned by Shenzhen DSQN Investment CO., LTD.
COPYRIGHT 2011-2021 SARAMONIC INTERNATIONAL (A brand of DSQN)
Room 2009, Shenzhen Bairuida Bldg, Banxuegang Road, Bantian Street, Longgang District,
Shenzhen, China 518129 Tel: 400-613-1096 Email: info@saramonic.com

深圳市大盛青牛投资有限公司

广东省深圳市龙岗区坂雪岗大道百瑞达大厦A栋2009室

全国服务热线: 400-613-1096

中国制造 Made in China